

DR. JUDY WOOD

202 Mulberry Ave.
Clemson, SC 29631
864-654-8271

lisajudy@nctv.com

September 14, 2008

WTC Technical Information Repository
Attention: Mr. Stephen Cauffman
National Institute of Standards and Technology
Stop 8610
Gaithersburg, MD 20899-8610
Email: wtc@nist.gov

Re: Comments

Dear Mr. Stephen Cauffman:

Set forth below are comments on the "**Final Report on the Collapse of World Trade Center Building 7 Draft for Public Comment**" dated August 21, 2008 (NCSTAR 1A). The source of the said NCSTAR 1, meaning the point at which it can be and has been accessed, is: <http://wtc.nist.gov/>

First, the comment period provides insufficient time for comprehensive comment. That period should be extended for a minimum of ninety (90) additional days. Further, and as seen below, several of the comments that are made herein indicate that NCSTAR 1-A is misleading to the point of being fraudulent.

NIST should also publish all comments received in their entirety. If NIST does not do so, then NIST should at least acknowledge that one commentator, Dr. Judy Wood, requested that NIST do so and NIST should then explain that such comments can be obtained by the public upon request and should further indicate the reason for not publishing all comments it received.

I am represented in connection with these comments by Attorney Jerry V. Leaphart whose contact information is set out at the end of the comments. If you have any questions, please contact either me or my counsel.

Comment 1

Issue: Listing of Contributors

Location: page 8-10 of 115 of pdf, (labeled page vi-viii of report)
http://wtc.nist.gov/media/NIST_NCSTAR_1A_for_public_comment.pdf

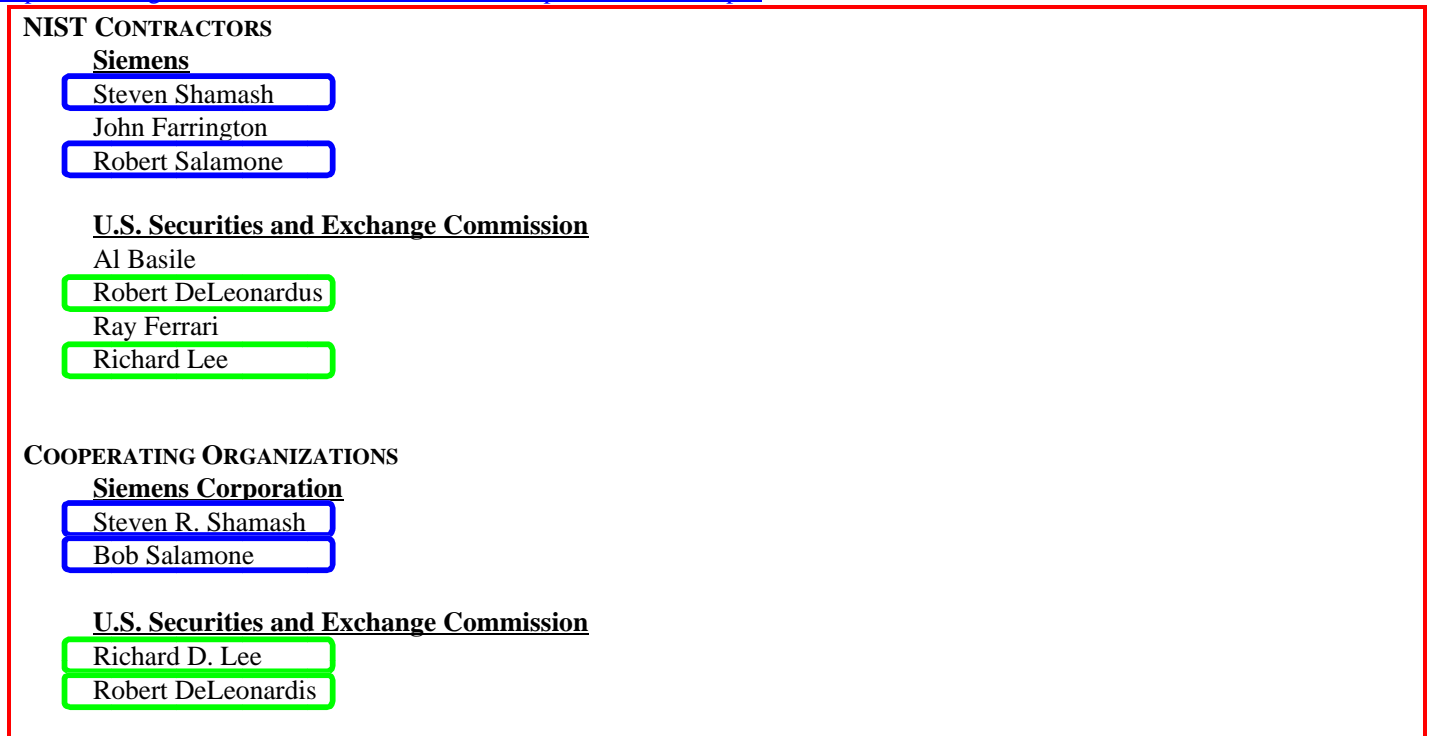

Figure 1.
page 9-10 of 115 of pdf, (labeled page vii-viii of report)
http://wtc.nist.gov/media/NIST_NCSTAR_1A_for_public_comment.pdf

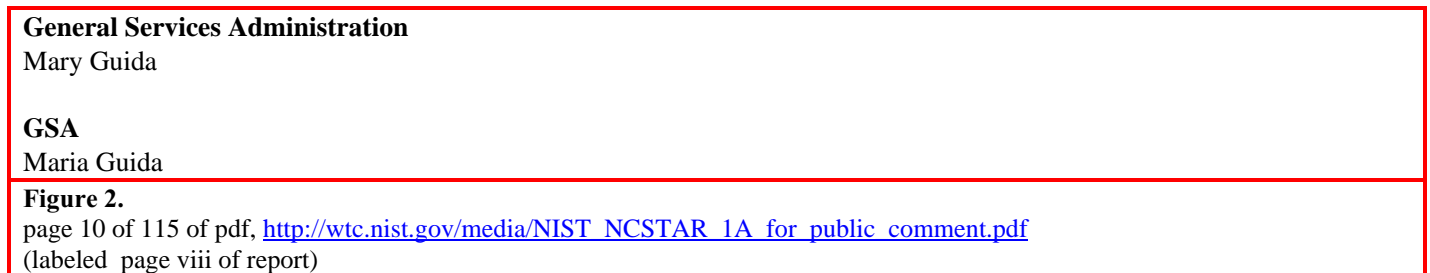

Figure 2.
page 10 of 115 of pdf, http://wtc.nist.gov/media/NIST_NCSTAR_1A_for_public_comment.pdf
(labeled page viii of report)

Reason for Comment: The listings are inconsistent with individuals being listed as paid contractors and cooperating organizations. This should be clarified. Mary Guida is listed twice (GSA is listed twice).

Suggestion for Revision: Delete or modify as necessary.

Comment 2

Issue: **Reference to weather**

Location: Beginning of Section 2.1 pg. 51, paragraph 1.

Chapter 2 The Account of WTC 7	13
2.1 Introduction	13

2.1 INTRODUCTION

Shortly before 9:00 a.m. on Tuesday, September 11, 2001, about 4,000 people were at work in WTC 7. This was about half of the roughly 8,000 people who worked there. It was the first day of school for many local children, and it also was a primary election day in New York. The weather was clear and comfortable, so some had taken time to do early morning errands.

Figure 3.

page 51 of 115 of pdf (labeled page of report), http://wtc.nist.gov/media/NIST_NCSTAR_1A_for_public_comment.pdf

Reason for Comment: The reference is casual and is based on commonly held assumptions, but is not sufficient for a comprehensive and detailed report. Because of the magnitude of the destruction that NIST itself describes as “disproportionate” it is necessary to have a proper understanding of the precise weather mechanism that may have impacted upon the unprecedented destructive events that occurred.

Suggestion for Revision: It is not commonly known or appreciated that a massive Category 3 hurricane was located offshore New York on 9/11/01. That was Hurricane Erin, as seen here:

Hurricane Erin on 9/11/01

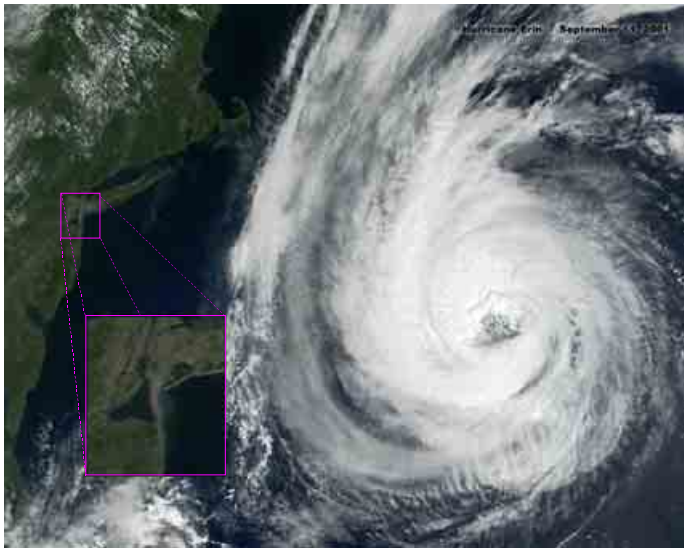

Figure 4. <http://911digitalarchive.org/REPOSITORY/IMAGES/PHOTOS/1867.ppt>,
http://drjudywood.com/articles/erin/hpics/010911_1867.jpeg



Figure 5. http://svs.gsfc.nasa.gov/vis/a000000/a002500/a002521/wtc_terra1.tif,
http://drjudywood.com/articles/erin/noaapics/010911_wtc_terra1_s.jpg



Figure 6. http://svs.gsfc.nasa.gov/vis/a000000/a002500/a002521/wtc_terra1.tif, http://drjudywood.com/articles/erin/noaapics/010911_wtc_terra1_cbc.jpg

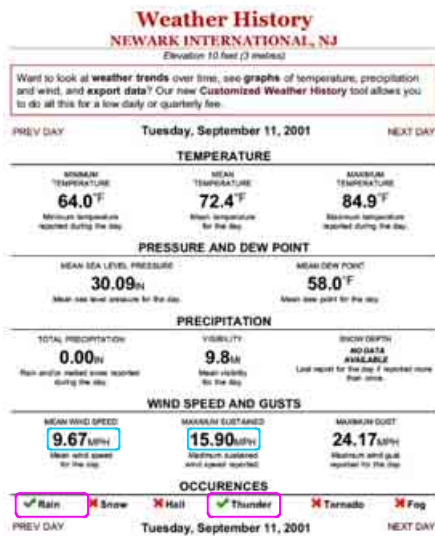

Figure 7. Weather at Newark International Airport, Newark, NJ, on 9/11/01.

<http://www.almanac.com/weatherhistory/index.php?day=11&month=9&year=2001>



Figure 8. Weather at Laguardia International Airport, New York, on 9/11/01.

<http://www.almanac.com/weatherhistory/index.php?day=11&month=9&year=2001>



Figure 9. Weather at J.F. Kennedy International Airport, New York, on 9/11/01.

<http://www.almanac.com/weatherhistory/index.php?day=11&month=9&year=2001>

Locations where rain and thunder were recorded.



Figure 5-3. Map of the lower portion of Manhattan showing the location of the WTC complex relative to the island. Figure 10. Page 138 of 404 of pdf (labeled page 94 of report), http://wtc.nist.gov/media/NIST_NCSTAR_1-9_Vol1_for_public_comment.pdf

NHC Data (9/9/01 - 9/12/01)

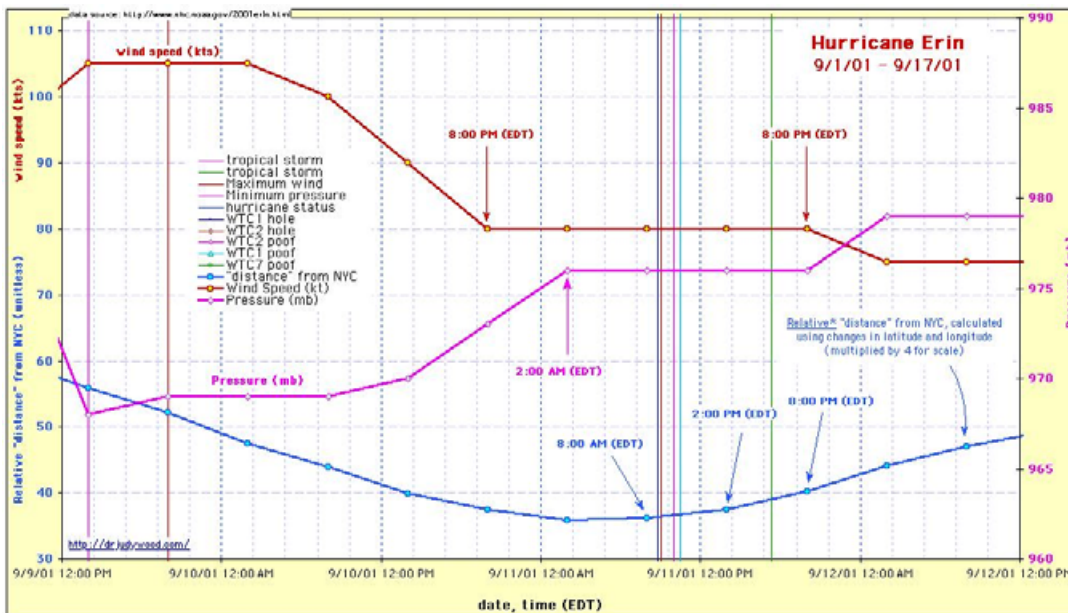

Figure 11. nhc <http://www.nhc.noaa.gov/2001erin.html> 2001_erin_close.jpg

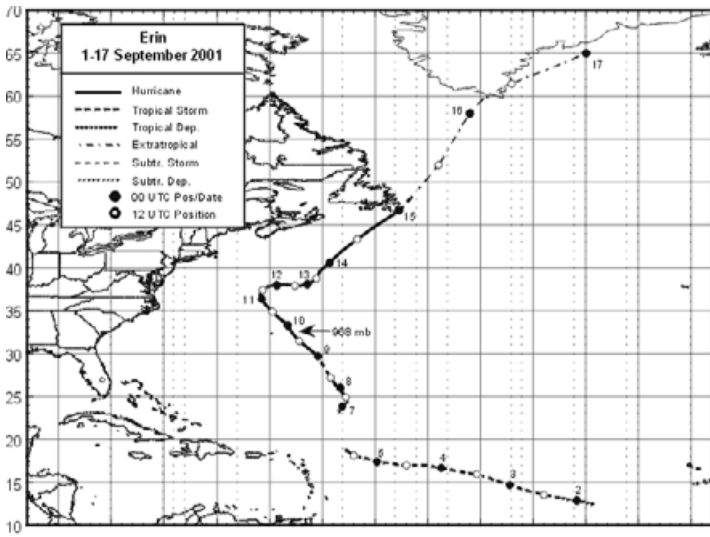

Figure 12. Best track for Hurricane Erin, September 2001. Track during the extratropical stage is based on analyses from the NOAA Marine Prediction Center.

<http://www.chc.noaa.gov/2001erin.html>

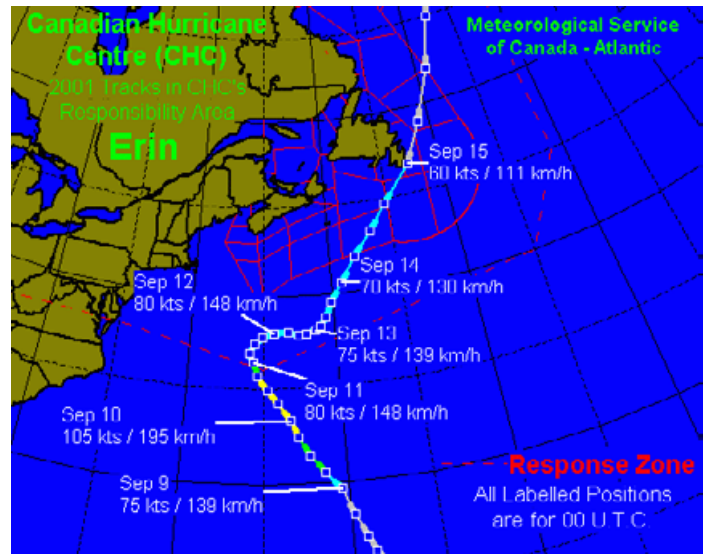

Figure 13. Hurricane Erin track (atl.ec.gc.ca). According to the Canadian Hurricane Centre (CHC), Hurricane Erin entered the "Response Zone." A hurricane in this zone should presumably trigger a "response."

http://www.atl.ec.gc.ca/weather/hurricane/images/2001/erin2001_e.gif

Eye of Hurricane Erin at approximately 8 AM, 9/11/01

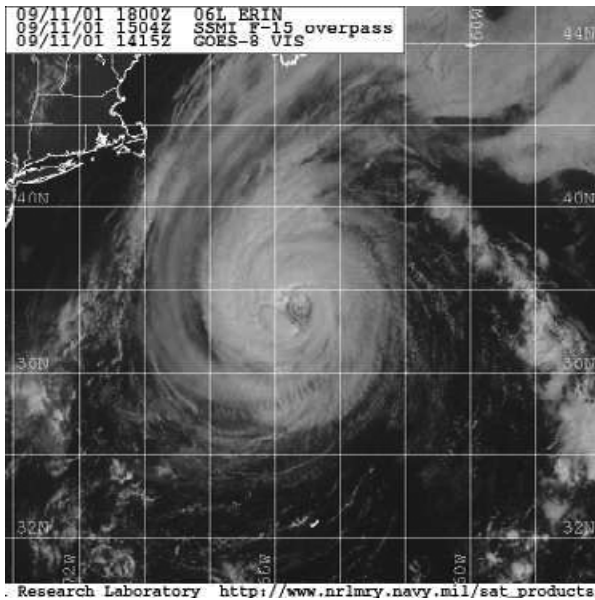

Figure 14. Hurricane Erin, September 11, 2001, at about 37.4°N, 65.6°W, which corresponds to about 10:15AM (EDT).

Source: http://www.aoml.noaa.gov/hrd/Storm_pages/erin2001/20010911ERIN.jpg

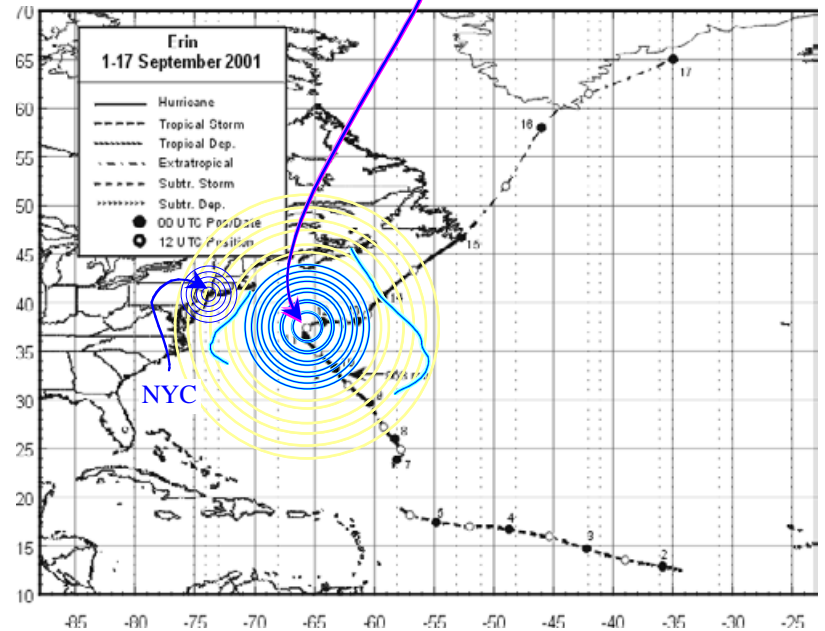

Figure 15. . Best track of Hurricane Erin, September 1-17, 2001

Source: <http://www.chc.noaa.gov/prelims/2001/erin1.gif> , <http://www.chc.noaa.gov/2001erin.html>

Comment 3

Issue: Analysis of the buckling is substantially incomplete.

Location: page 34 of 115 of pdf, (labeled page xxxii of report), paragraph 2

http://wtc.nist.gov/media/NIST_NCSTAR_1A_for_public_comment.pdf

PRINCIPAL FINDINGS OF THE INVESTIGATION

Eventually, the fires reached the northeast of the building. The probable collapse sequence that caused the global collapse of WTC 7 was initiated by the buckling of a critical interior column in that vicinity. [This column had become unsupported over nine stories after initial local fire-induced damage led to a cascade of local floor failures. The buckling of this column led to a vertical progression of floor failures up to the roof and to the buckling of adjacent interior columns to the south of the critical column.](#) An east-to-west horizontal progression of interior column buckling followed, due to loss of lateral support to adjacent columns, forces exerted by falling debris, and load redistribution from other buckled columns. The exterior columns then buckled as the failed building core moved downward, redistributing its loads to the exterior columns. Global collapse occurred as the entire building above the buckled region moved downward as a single unit. This was a fire-induced progressive collapse, also known as disproportionate collapse, which is defined as the spread of local damage, from an initiating event, from element to element, eventually resulting in the collapse of an entire structure or a disproportionately large part of it.

Figure 16. [emphasis added]

page 34 of 115 of pdf, (labeled page xxxii of report)

http://wtc.nist.gov/media/NIST_NCSTAR_1A_for_public_comment.pdf

Reason for Comment: Analysis explaining exactly how an interior progressive collapse and complete unit global collapse occurred. The likelihood of asymmetry converting to symmetry is highly unlikely and without detailed engineering descriptions, borders on incredible.

Suggestion for Revision: Crucial to the viability of the probable collapse sequence articulated in this report is that the [dimensions] column would have had to become unsupported over nine stories. We also note that we relied on the soundtracks of available video to refute hypothetical blast events as a causal factor. We did not engage in an analysis of the soundtracks to determine whether the audible sounds could be deemed to be consistent with a [dimension] column becoming unsupported. We have no explanation for why we did not engage in that analysis.

Comment 4

Issue: Failure due to thermal expansion in buildings does not happen at low temperatures. To suggest this disregards the known properties of materials.

Location: First use at Pg. 34 (pdf) Executive Summary, plus, comment pertains to all 37 uses of that term throughout NCSTAR 1-A, paragraph 3

PRINCIPAL FINDINGS OF THE INVESTIGATION

Factors contributing to the building failure were: thermal expansion occurring at temperatures hundreds of degrees below those typically considered in design practice for establishing structural fire resistance ratings; significant magnification of thermal expansion effects due to the long-span floors, which are common in office buildings in widespread use; connections that were designed to resist gravity loads, but not thermally induced lateral loads; and a structural system that was not designed to prevent fire-induced progressive collapse.

Figure 17.

page 34-5 of 115 of pdf, (labeled page xxxii - xxxii of report)

http://wtc.nist.gov/media/NIST_NCSTAR_1A_for_public_comment.pdf

Reason for Comment:

Issue: 3 with 1 pages

The term “thermal expansion” does not appear to have any clearly articulated scientific basis in reality; nor does NCSTAR 1-A adequately explain how the concept of thermal expansion, as articulated, could have arisen in connection with steel columns, girders, and beams that were fire proofed.

December 18, 2007 NCST meeting

Charlie Thornton: Let me ask another question. How long does a 4 pound per square foot combustibile office building fire generally last?

Shyam Sunder: The rule of thumb for 10 pounds per square feet is one hour. Four pounds is 20 minutes.

Charlie Thornton: So again, why would these fires have burned for as long as they did in order to take out this rather well fireproofed heavy robust structure?

Shyam Sunder: Charlie, what I'm saying – I guess I'm not communicating well what I'm saying, which is that the fire at any one location is consumed in 20 minutes where the fire front is, but then it moves to the next place where there's more combustibles.

Charlie Thornton: But if you're saying that beams sagged and buckled and pulled, O K, that had to be exposed to the fire for more than 20 minutes.

Shyam Sunder: Well, the temperatures at which the beams are exposed, that is the critical issue here, not how long they were exposed to that temperature, and of course beams and slabs and any fireproofing – concrete slab - the metal deck may have some. The beams are much more slender elements in terms of thermal mass and of course the fireproofing on the beams, the floor beams, are much less than the fireproofing on the girders and of course the columns. And so when you go through the analysis for these fires which are moving around from location to location, on those particular floor beams, you see a considerable amount of temperature increases. In fact, you'll see temperatures getting up in to ...in certain regions to 5 600 degrees. Now what also compounds this is you have these heating elements in very large spans in the northeast side of the building. As we said before, there were 2000 square feet large spans, floor areas ... for those columns. So those spans were in fact sagging and we're seeing evidence through our analysis of these very large magnitude of sag.

[There is a loud hammering/knocking sound at this part of the recording as though carpenters were hammering on something in the room. This made Charlie's next remark difficult to hear.]

Charlie Thornton: I mean it sounds to me, it sounds to me like between the words here you're questioning the use of ___?_ fireproofing for a two-hour rating on a W 21 wide flange beam as an effective fireproofing in the absence of sprinkler systems.

Bill Gross: Can I add two things to Shyam's [remarks]. Charlie, you can have an ignition event quite early in the process in which the fire does not burn robustly but smolders and, you know, is barely maintained. And unlike the Towers where you had so much fuel distributed in which the fires spread very quickly, you could have a fire ignited and not grow very fast. It reaches then a certain critical size and then it begins moving as Shyam described. That's one thing.

The second, this would have to be literally a matter of an hour or two where it could be burning at a very slow rate and then burst out in to a full fledged floor fire.

The second thing is don't forget that once the fire front passes, you still a lot of amount of heat there, so the cool-down period following the consumption of most of the fuel – it's still very very hot and will last for a couple of hours, so that adds to the heating of the structure.

Shyam Sunder: Yes, that's a very good point, Bill. The fire front moves but the heated elements don't cool down.

Bob ____: Shyam, this is Bob. I ran down the same question that Charlie did some time ago

Shyam: O K

Bob: The same concern. The basic point is that this was a bank fire, and we did the temperature study by using the model, the fire dynamic simulator model, and the temperature... it was more like a series of burners coming on at 20-minute intervals, and as you said, pumping heat into the building, losing some through the vents, having other sink into

the material, and the model gave us the fire that they are using. We transferred all of the temperatures on the back side of the fireproofing and then compared those to the properties of the steel or the concrete as the case may be and fed in to the structural model these changes in qualities.

Shyam Sunder: Yes, I think that that is an important point that, Charlie, we aren't making any assumptions in this thing. The models are very detailed, so the fire dynamics model gives us the information on the gas temperatures. The thermal model, which is using also LS-DYNA, which is not the structural model, the model, the fireproofing and the structural elements, the seal (?) elements there. So basically, the gas temperatures actually predicting the rise of the temperature in the steel through the fireproofing, and that is done with considerable detail, and then at that point, the structural model comes in to play.

Charlie Thornton: I'm not questioning what you're doing. I'm questioning the way that American architects and structural engineers design buildings with spray-on fireproofing. I think you're basically coming out with a conclusion that maybe it doesn't work.

Shyam Sunder: I think I will hold off on making a recommendation at this point. Your input is certainly very meaningful to us and as we go forward here, you know, at the end of the day when all of this analysis is finished and we can conclude definitively what we have actually accomplished. At that point I think we will in a position to make a statement about design practices."

The foregoing exchange clearly questions the efficacy of reliance on an unexplained concept of "thermal expansion" as a causal factor in the destruction of WTC 7.

Figure 18. from Transcript of NCST December 18, 2007 meeting.

NIST's use of a thermal expansion, occurring at "low temperature" is insufficiently elaborated. Clearly, NIST is trying to navigate a very narrow factor of plausibility here, and that is the most that can be said about it. On the one hand, thermal expansion might, in very generous theoretical terms be said to result in certain effects. However, if the temperature is too high, then a softening of material occurs, which would negate the necessary strength needed to cause expansion. Accordingly, absent a detailed indication of what temperature is low enough to cause expansion, while simultaneously not causing loss of strength is crucial. It may well be that there is no such temperature. In any event, NIST must, at a minimum specify what temperature it has reason to believe was achieved and how the conditions known could have resulted in that temperature. We understand, as well, that there are some who will question the validity of the use of this concept and who may claim that NCSTAR 1-A is fraudulent.

Suggestion for Revision:

NIST data show that X temperature was achieved and documents that following conditions occurred at that temperature [details]

NIST also acknowledges, in this respect that there are some who will question the validity of the use of this concept and who may claim that NCSTAR 1-A is fraudulent.

Comment 5

Issue: Limiting the analysis to properties of the soundtracks to hypothetical blast events is fraudulent

Location: page 34 of 115 of pdf, (labeled page xxxii of report), paragraph 5
http://wtc.nist.gov/media/NIST_NCSTAR_1A_for_public_comment.pdf

PRINCIPAL FINDINGS OF THE INVESTIGATION

Hypothetical blast events did not play a role in the collapse of WTC 7. NIST concluded that blast events did not occur, and found no evidence whose explanation required invocation of a blast event. Blast from the smallest charge capable of failing the critical column would have resulted in a sound level of 130 dB to 140 dB at a distance of at least half a mile. There were no witness reports of such a loud noise, nor was such a noise heard on the audio tracks of video recordings of the WTC 7 collapse.

Figure 19. [emphasis added]
page 34 of 115 of pdf, (labeled page xxxii of report)
http://wtc.nist.gov/media/NIST_NCSTAR_1A_for_public_comment.pdf

Reason for Comment: NIST’s acknowledgment that the soundtracks from available videos were used in connection with the analysis of hypothetical blast events requires, for sake of consistency of analysis, that such soundtracks also be used to substantiate (or refute) the findings that NIST made in connection with its other findings. The failure to do so is consistent with fraud.

Suggestion for Revision: We understand, as well, that there are some who will question the validity of limiting our analysis of the properties of the soundtracks to hypothetical blast events. We have no explanation for doing so and if there are those who wish to assert that our failure in this respect is fraudulent, then they may do so. We acknowledge being placed on notice of this claim of fraud in comments received from Dr. Judy Wood.

Comment 6

Issue: Building structure as given in the document(s) is incomplete – therefore the analysis is incomplete.

Location: page 43 of 115 of pdf, (labeled page 5 of report), 2nd paragraph from bottom
http://wtc.nist.gov/media/NIST_NCSTAR_1A_for_public_comment.pdf

Chapter 1 The New York City World Trade Center Building 7	1
1.1 The World Trade Center Complex	1
1.2 WTC 7	1
1.2.1 The Edifice.....	1
1.2.2 The Con Edison Substation.....	3
1.2.3 The Structure	5

From the 7th floor to the 47th floor, WTC 7 was supported by 24 interior columns and 58 perimeter columns (numbered 1 through 57, plus 14A, which was located near the south end of the west face) (Figure 1 5). Twenty one of the interior columns (numbered 58 through 78) formed a rectangular building core, which was offset toward the west of the building. The remaining three interior columns (79, 80, and 81) were particularly large, as they provided support for the long floor spans on the east side of the building.

Figure 20. [emphasis added]
page 43 of 115 of pdf, (labeled page 5 of report) http://wtc.nist.gov/media/NIST_NCSTAR_1A_for_public_comment.pdf

Reason for Comment:

Use of generic, non-specific language – “three interior columns (79, 80, and 81) were particularly large” is unsatisfactory for a report that must comply with the standards of the Information Quality Act. The dimensions of those columns must be specific. Full drawings and material specifications related to the building must be available in the report.

Suggestion for Revision:

The three interior columns (79, 80, and 81) were of the following dimensions: [provide length, width, breadth and weight]. NIST could not confirm via the available soundtracks that columns of that dimension could be heard crashing down. [Or, in the alternative]: NIST correlated the sound of crashing of columns in the soundtracks for videos taken at sites __, __.

Comment 7

Issue: Dimensions and weights of beams must be provided.

Location: page 44 of 115 of pdf, (labeled page 6 of report), paragraph 1
http://wtc.nist.gov/media/NIST_NCSTAR_1A_for_public_comment.pdf

Chapter 1 The New York City World Trade Center Building 7.....	1
1.2 WTC 7	1
1.2.3 The Structure	5

The floor slabs were reinforced concrete of varying thickness. The 1st floor slab was 14 in. thick. The concrete on almost all of the other floors was poured on top of 3 in. deep corrugated metal decking. Floors 2, 3, 4, and 6 had a 6 in. total slab thickness; on Floor 5, the concrete was 14 in. thick; and on Floors 8 through 47, the concrete was 5.5 in. thick. On Floor 7, the south half of the floor had a poured 8 in. slab, and the north half had an 8 in. total slab thickness on a 3 in. deep metal deck. The floor slabs were supported by the structural floor framing shown in [Figure 1-5](#). The floor beams were connected to the concrete deck by shear studs, which caused the floor beams and concrete slab to act together, or compositely. This type of floor system is thus referred to as a composite floor. The floor beams were framed into (connected to) girders with a variety of types of shear connectors, through which the floor beams transferred gravity loads from the floors to the girders. The girders also framed into the columns with a variety of types of shear connectors and transferred the gravity loads to the columns. Interior columns were connected with splice plates, welds and bolts. The exterior frame had moment connections in each face of the building.

Figure 21. [emphasis added]
page 44 of 115 of pdf, (labeled page 6 of report) http://wtc.nist.gov/media/NIST_NCSTAR_1A_for_public_comment.pdf

Reason for Comment: Building structure as given in the document(s) is incomplete – therefore the analysis is incomplete. Location of beams alone is insufficient to make a valid assessment. Much more structural information needs to be included, with more specific details of dimensions, weights and materials involved for anything which fell to the ground.

Suggestion for Revision: NIST has determined that the dimensions of the beams referenced here are as follows: [provide dimensions]

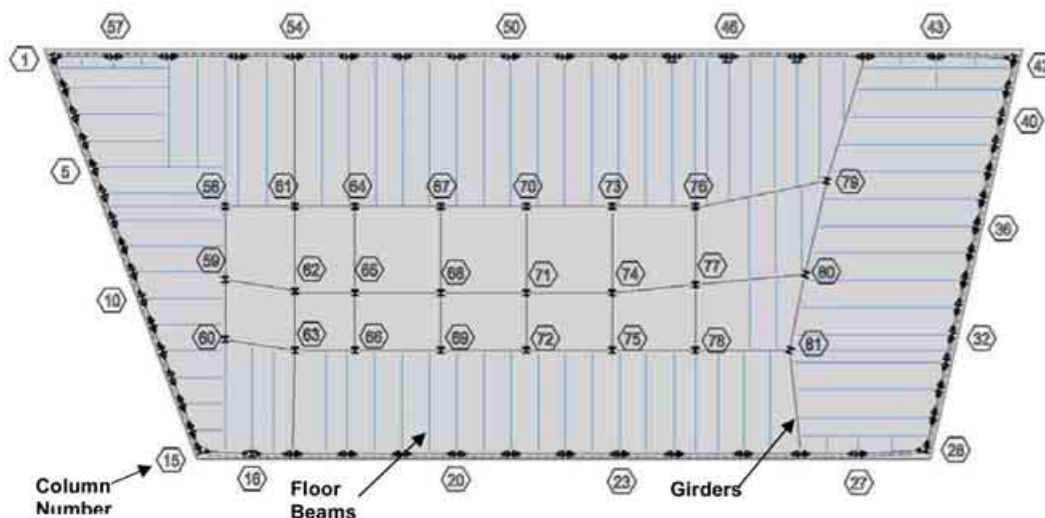

Figure 1–5. Typical WTC 7 floor showing locations of the columns, girders, and beams..

Figure 22. page 44 of 115 of pdf (labeled page 6 of report),
http://wtc.nist.gov/media/NIST_NCSTAR_1A_for_public_comment.pdf

Comment 8

Issue: Aspect ratio of beams

Location: Page 346 of 382 of pdf (labeled page 684 of report), page 127 of 382 of pdf (labeled page 465 of report)
http://wtc.nist.gov/media/NIST_NCSTAR_1-9_vol2_for_public_comment.pdf

Section	Web Height	Flange Width	Flange Thickness	Web Thickness
W14X730	22.4	17.9	4.91	3.07
W14X665	21.6	17.7	4.52	2.83

Figure 23.

Page 346 of 382 of pdf (labeled page 684 of report), http://wtc.nist.gov/media/NIST_NCSTAR_1-9_vol2_for_public_comment.pdf

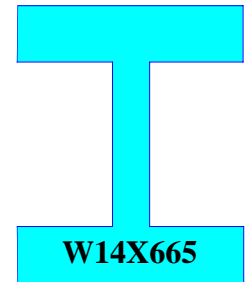
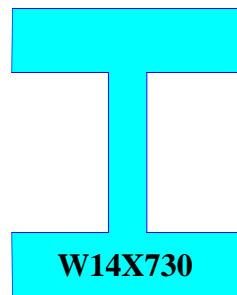
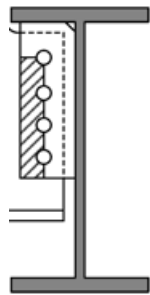

page 127 of 382 of pdf (labeled page 465 of report),
http://wtc.nist.gov/media/NIST_NCSTAR_1-9_vol2_for_public_comment.pdf

The aspect ratio of the dimensions provided in Table D1 are shown above.

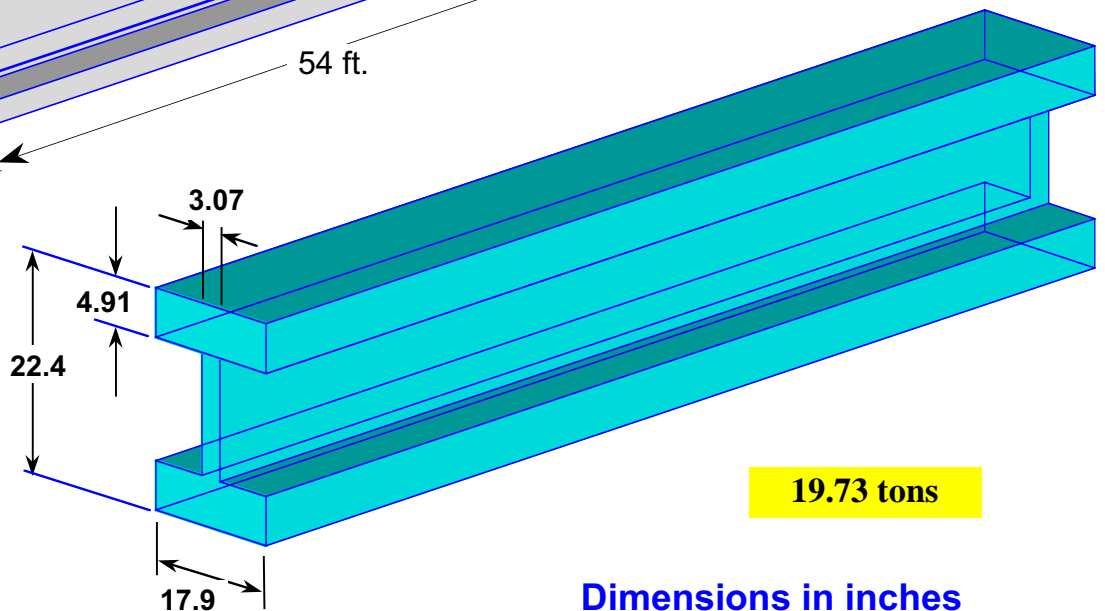
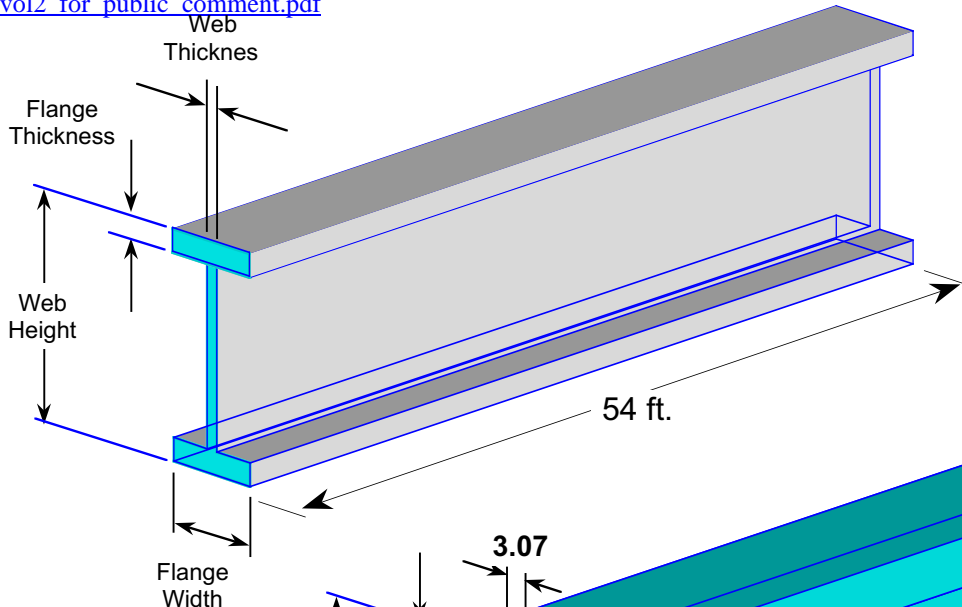

Dimensions in inches

Reason for Comment: The aspect ratio of beam cross sections shown in the report do not have dimensions. The dimensions provided in the report describe beams with a very different aspect ratio. Dimensions and weights of beams used in this analysis must be provided so that the plausibility of NIST's theory can be properly assessed, among other things. Basically, we are led to believe that very large columns, beams and girders were all sufficiently heated by ordinary office fires that burned for no more than 20 minutes in any one area resulted in multiple, nearly simultaneous failure. That explanation is, of course, implausible, but, at a very minimum, accurate dimensions of what failed must be both provided in detail and properly diagrammed.

Because NCSTAR 1-A refers to collapsing beams, it is essential that the correct aspect ratio is depicted. Otherwise, a highly misleading report would be foisted on the public. We are already required to accept that a 47-story building could collapse in a matter of seconds. At a minimum, correct diagrams of what is said to have collapsed are required. If not, then the appearance of fraud is overwhelmingly confirmed.

Suggestion for Revision:

This revision requires re-do of diagrams as exemplified above to show correct aspect ratios.

Comment 9

Issue: Causes for the destruction other than fire and thermal expansion must be properly considered, using all available data.

Location: page 47-8 of 115 of pdf, (labeled page 9-10 of report)
http://wtc.nist.gov/media/NIST_NCSTAR_1A_for_public_comment.pdf

Chapter 1 The New York City World Trade Center Building 7	1
1.2.6 The Combustible Contents.....	9

1.2.6 The Combustible Contents

The layout of most of the floors featured clusters of workstations, or cubicles, throughout the space surrounding the building core (NIST NCSTAR 1-9, Chapter 3). Often, there were walled offices at the perimeter. The layout in Figure 1 8 is indicative of these floors. While there were almost certainly different types of workstations in the building, they were all fundamentally similar. Each cubicle typically was bounded on four sides by privacy panels, with a single entrance opening. Within the area defined by the panels was a self-contained workspace: desktop (almost always a wood product, generally with a laminated finish), file storage, bookshelves, carpeting, chair, etc. Presumably there were a variety of amounts and locations of paper, both exposed on the work surfaces and contained within the file cabinets and bookshelves.

The **combustible fuel load**³ for these open landscaped floors was dominated by the workstations. The architectural drawings showed densities of workstations similar to those on most of the fire floors in the WTC towers. The estimated combustible fuel load for these floors was about 20 kg/m² (4 lb/ft²). **Simulations of the fires with a higher combusted fuel load (NIST NCSTAR 19, Chapter 9) resulted in poor agreement with the observed fire spread rates.**

Figure 24. [emphasis added]
page 47-8 of 115 of pdf, (labeled page 9-10 of report)
http://wtc.nist.gov/media/NIST_NCSTAR_1A_for_public_comment.pdf

³ In the fire simulations, the entire combustible fuel load can be burned. In actuality, not all of, e.g., a wood desk is consumed. Thus, the combusted fuel loads estimated for these simulations are somewhat lower than the actual fuel loads in prior surveys of office buildings. (See NIST NCSTAR 15.)

Figure 25. [emphasis added] Footnote 3, page 48 of 115 of pdf, (labeled page 10 of report),
http://wtc.nist.gov/media/NIST_NCSTAR_1A_for_public_comment.pdf

Reason for Comment:

If it was the case that: “Simulations of the fires with a higher combusted fuel load (NIST NCSTAR 1-9, Chapter 9) resulted in poor agreement with the observed fire spread rates” this means the analysis is incomplete or incorrect. Full detailed resulting data from testing of combustible fuel load should be included in the report. If data from these repeatable tests does not match up well with observed fire spread rates, then further testing is necessary.

Suggestion for Revision:

Data: [Fully described, repeatable tests of combustibles within the building should be available which describe temperatures achieved (compared with materials fully documented in architectural documentation) as well as fire spread rates. These must be compared to expected heating and material failure specs of the actual materials in the building according to official architectural documents.]

Comment 10

Issue: Analysis for the fate of the fuel is incomplete.

Location: page 49 of 115 of pdf, (labeled page 11 of report),
http://wtc.nist.gov/media/NIST_NCSTAR_1A_for_public_comment.pdf

The base building tanks were full on September 11, 2001. Several months following the attacks on the WTC, a contractor recovered an estimated 23,000 gal of fuel from these tanks. NIST estimated that approximately 1000 gal \pm 1000 gal was unaccounted. The fate of the fuel in the three day tanks is unknown, so NIST assumed they were full on September 11, 2001.

The fate of the fuel in the two tanks for the SSB system was also unknown. Thus, NIST assumed that all of the fuel would have been available to feed fires either at ground level or on the 5th floor.

Figure 26. [[emphasis added](#)]

page 49 of 115 of pdf, (labeled page 11 of report),
http://wtc.nist.gov/media/NIST_NCSTAR_1A_for_public_comment.pdf

Reason for Comment: Incomplete audit of fuel from internal WTC7 fuel tanks and how it did or did not contribute to heating of the materials within the building prior to global symmetric collapse.

Suggestion for Revision:

DATA: [Provide audit of fuel available in the tanks pre-9/11 with fuel accounted for during cleanup.]

Comment 11

Issue: Incomplete analysis of what was heard.

Location: page 51 of 115 of pdf, (labeled page 13 of report)
http://wtc.nist.gov/media/NIST_NCSTAR_1A_for_public_comment.pdf

2.2 ACTIVITY AT THE WTC 7 SITE

2.2.1 8:46 a.m. to 9:59 a.m. EDT

People throughout WTC 7 heard the boom of the aircraft hitting WTC 1, which was only about 110 m (350 ft) to the south. Lights flickered, the building shook, and some windows on the south side of WTC 7 were broken.

However, few, if any, of the workers felt their lives were in immediate danger. This perception changed as the occupants became aware of the subsequent attacks on WTC 2 and the Pentagon, and people began using the elevators and stairs to leave the building. The elevators alone could have evacuated the building in about 20 min. The stairwells, although somewhat narrow for the maximum possible 14,000 occupants (estimated using the formula in the NYCBC), were more than adequate to evacuate roughly one third of that number in the building that morning (NIST NCSTAR 19, Chapter 7).

Figure 27. [emphasis added]
page 51 of 115 of pdf, (labeled page 13 of report) http://wtc.nist.gov/media/NIST_NCSTAR_1A_for_public_comment.pdf

Reason for Comment:

Use of language is not specific enough “People throughout the building...” The description of the sound is also vague. Determine and include how many people heard the “boom”. The description of the sound needs to be clearer – did it sound more like a crash, or an explosion? All subjective comments must be supported by actual statements that will verify what exactly individuals heard and how they corroborate to each other. Statistical analyses should be conducted of witness statements to ensure consistency of said statements to insure that readers of this report only hear objective data. This could then be compared with public domain analyses of eyewitness statements to ensure consistency.

Suggestion for Revision:

NIST has determined with reasonable certainty the assertions concerning what was heard based on the following accounts and soundtracks [provide data]

Comment 12

Issue: It would be like raining dump trucks.

Location: page 58 of 115 of pdf, (labeled page 20 of report),
http://wtc.nist.gov/media/NIST_NCSTAR_1A_for_public_comment.pdf

The upper section of Column 79 began to descend. The cascading failures of the lower floors surrounding Column 79 led to increased unsupported length in, falling debris impact on, and loads being redistributed to adjacent columns; and Column 80 and then Column 81 buckled as well. All the floor connections to these three columns, as well as to the exterior columns, failed, and the floors fell on the east side of the building. The exterior façade on the east quarter of the building was just a hollow shell.

The failure then proceeded toward the west. Truss 2 (Figure 1-6) failed, hit by the debris from the falling floors. This caused Column 77 and Column 78 to fail, followed shortly by Column 76. Each north-south line of three core columns then buckled in succession from east to west, due to loss of lateral support from floor system failures, to the forces exerted by falling debris, which tended to push the columns westward, and to the loads redistributed to them from the buckled columns. Within seconds, the entire building core was failing.

The global collapse of WTC 7 was underway. The shell of exterior columns buckled between the 7th and 14th floors, as loads were redistributed to these columns due to the downward movement of the building core and the floors. The entire building above the buckled-column region then moved downward as a single unit, completing the global collapse sequence.

Figure 28.
page 58 of 115 of pdf, (labeled page 20 of report) http://wtc.nist.gov/media/NIST_NCSTAR_1A_for_public_comment.pdf

Reason for Comment:

Analysis of columns 79, 80, 81, is incomplete. Much more structural information needs to be included, with more specific details of dimensions, weights and materials involved. Comprehensive re-analysis of the sound of the destruction is required – and considered in the light of the seismic readings. I.e. there was a great volume of heavy material coming down to the ground, which would have made very loud noise, but this was not observed. This must be addressed. This section describes the gravitational failure of several columns during the initiation of internal progressive collapse without including sound analysis of falling debris based on architectural documentation and material specs. Analysis of the audible recordings and sound properties of materials specified in the building should be included in the report to understand comparisons with similar weight objects as they are affected by gravity and collide with materials below.

Suggestion for Revision:

NIST realizes that the sound properties associated with the progressive collapse hypothesized in this report would have been quite pronounced. Detailed confirmation of the sound can be found in [provide data]

Or in the alternative

NIST has not been able to find any soundtrack containing crashing sounds that would corroborate the theory of collapse articulated in this report. However, NIST still maintains its belief in the plausibility of its explanation even though no audible confirmation could be found.

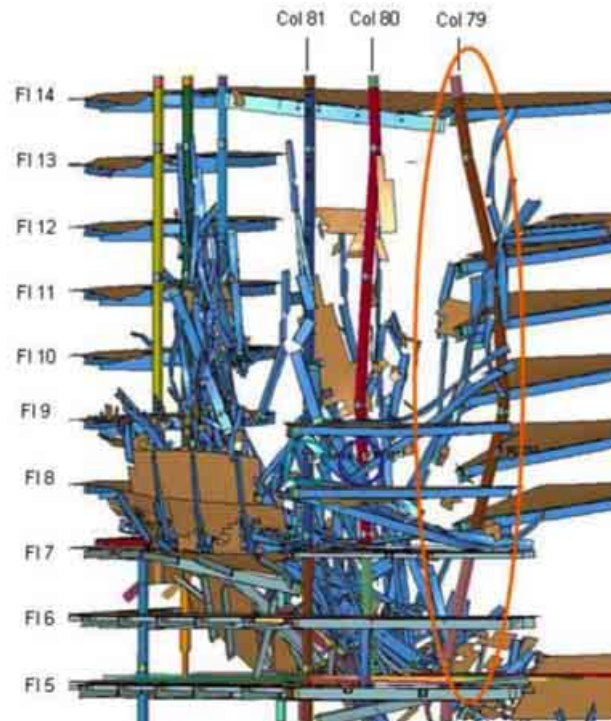

Figure 2–2. Eastward buckling of Column 79, viewed from the southeast.
Figure 29. page 58 of 115 of pdf, (labeled page 20 of report),
http://wtc.nist.gov/media/NIST_NCSTAR_1A_for_public_comment.pdf

Comment 13

Issue: No mention of fire, heat or smoke on floors 4,5,6 casts doubt on NIST's analysis of fire immediately above those floors.

Location:

Based on these analyses and review of the numerous interview transcripts⁵, NIST concluded that it was highly unlikely that any fires on the 5th or 6th floors contributed significantly to the collapse of WTC 7. NIST concluded that the only fires that could have led to structural weakening of WTC 7 were those on the 7th through 9th and 11th through 13th floors.

⁵ For instance, sometime after 1:00 p.m., OEM and FDNY staff climbed the east stairway of WTC 7 and did not see much damage on the 4th, 5th, or 6th floors from their viewing location. They made **no mention of fire, heat or smoke.**

Figure 30. [**emphasis added**]

page 64 of 115 of pdf, (labeled page 26 of report) http://wtc.nist.gov/media/NIST_NCSTAR_1A_for_public_comment.pdf

Reason for Comment:

No mention of fire, heat or smoke on floors 4,5,6 casts doubt on NIST's analysis of fire immediately above those floors. Careful consideration of actual damage to floors 4, 5 and 6 needs to be made. Their structure (and those of other floors) cannot have been completely destroyed by the “thermal expansion” can “collapse” of the upper floors.

Documentation of eyewitnesses indicates little or no damage on various indicated floors, including fire, heat or smoke. A more realistic analysis of the destruction of all floors not affected by fire needs to be included.

Suggestion for Revision:

NIST recognizes that the hypothesis of the effect of fires on floors above 6 is inconsistent with what was seen to have occurred on floors 4,5 and 6. We assert that the following specific evidence was used to account for that difference [provide data]

Or, in the alternative.

NIST recognizes that the hypothesis of the effect of fires on floors above 6 is inconsistent with what was seen to have occurred on floors 4,5 and 6. NIST has no data to account for the difference, but nonetheless maintains that it can make the claims made for fires above floor 6.

Comment 14

Issue: Spontaneous disintegration

Location: page 58 of 115 of pdf, (labeled page 20 of report)

http://wtc.nist.gov/media/NIST_NCSTAR_1A_for_public_comment.pdf

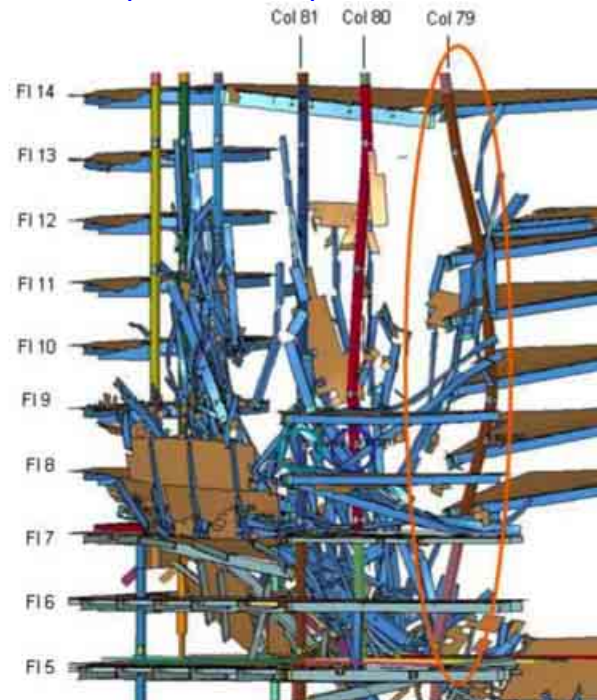

Figure 2–2. Eastward buckling of Column 79, viewed from the southeast.

Figure 31.

page 58 of 115 of pdf, (labeled page 20 of report),

http://wtc.nist.gov/media/NIST_NCSTAR_1A_for_public_comment.pdf

Reason for Comment:

Unless the building structure spontaneously disintegrated, when horizontal beams are removed from one side of a column, there should still be beams connected to the other side of the column. So, the column will not be unsupported. With less loading on the columns, they are less likely to fail. If a beam connected to one side had been removed, the beam on the other side is less constrained which would reduce the stress.

Suggestion for Revision:

NIST nevertheless acknowledges that unless the building structure spontaneously disintegrated, when horizontal beams are removed from one side of a column, there should still be beams connected to the other side of the column. So, the column will not be unsupported. With less loading on the columns, they are less likely to fail. If a beam connected to one side had been removed, the beam on the other side is less constrained which would reduce the stress.

Comment 15

Issue: Failure to include magnetometer and failure to properly use seismic data

Location: page 315 of 382 of pdf, (labeled page 653 of report) http://wtc.nist.gov/media/NIST_NCSTAR_1-9_vol2_for_public_comment.pdf

B.3 PREVIOUSLY IDENTIFIED SEISMIC EVENTS AT WTC

In September 2001, researchers at LDEO analyzed seismic records from the WTC disaster and reported their findings for five major events at the WTC site (Kim et al., 2001); the event time, equivalent magnitude on the Richter scale, the dominant period of ground vibration, and the duration of the signal are shown in Table B2 for the major events. The origin times listed in column 3 of Table B2 are taken Table 53 from Kim, et al. (2001), and were also used in the FEMA report (McAllister 2002). These

Figure 32. [\[emphasis added\]](#)

page 315 of 382 of pdf, (labeled page 653 of report) http://wtc.nist.gov/media/NIST_NCSTAR_1-9_vol2_for_public_comment.pdf

Reason for Comment:

Seismic data makes no comparisons to other comparable seismic events such as blasts related to TNT (in tons) relating to building size. Full comparisons of expected seismic activity should be made with other structures based on mass and substructure composition compared with seismic expectations of certain volumes of TNT. Any anomalies should be evaluated and determinations of these variations should be explained. If additional data, such as magnetometer data that corresponds to the onset of the events at the WTC as well as the final failure at WTC7 is available and suggests a correlation, this correlation should be included in the report and analyses conducted and findings documented.

The impact of the debris from WTC7 registered an equivalent to 0.6 on the Richter Scale. This is the magnitude of a signal that might be expected if WTC7 had lost at least 99% of its mass, evenly, over the height of the building.

Significant and important magnetometer data exists and must be included. That data consists in the following.

Analysis of that data, in conjunction with seismic data results in important information that will cast doubt on the probable collapse scenario in NCSTAR 1-A. We anticipate that NIST may not use this data and that, instead, the failure to do so will have to await further proceedings, such as a Request for Correction. NIST is hereby placed on notice that the failure to include the data is inexcusable.

Suggestion for Revision:

Magnetometer + seismic + "Our seismic "



Figure 33. . North face of WTC2 shows an unusual distortion in the image.
 (9/11/01) Source: http://ken.jp31.net/gallery/albums/wtc/img_1500_001.jpg

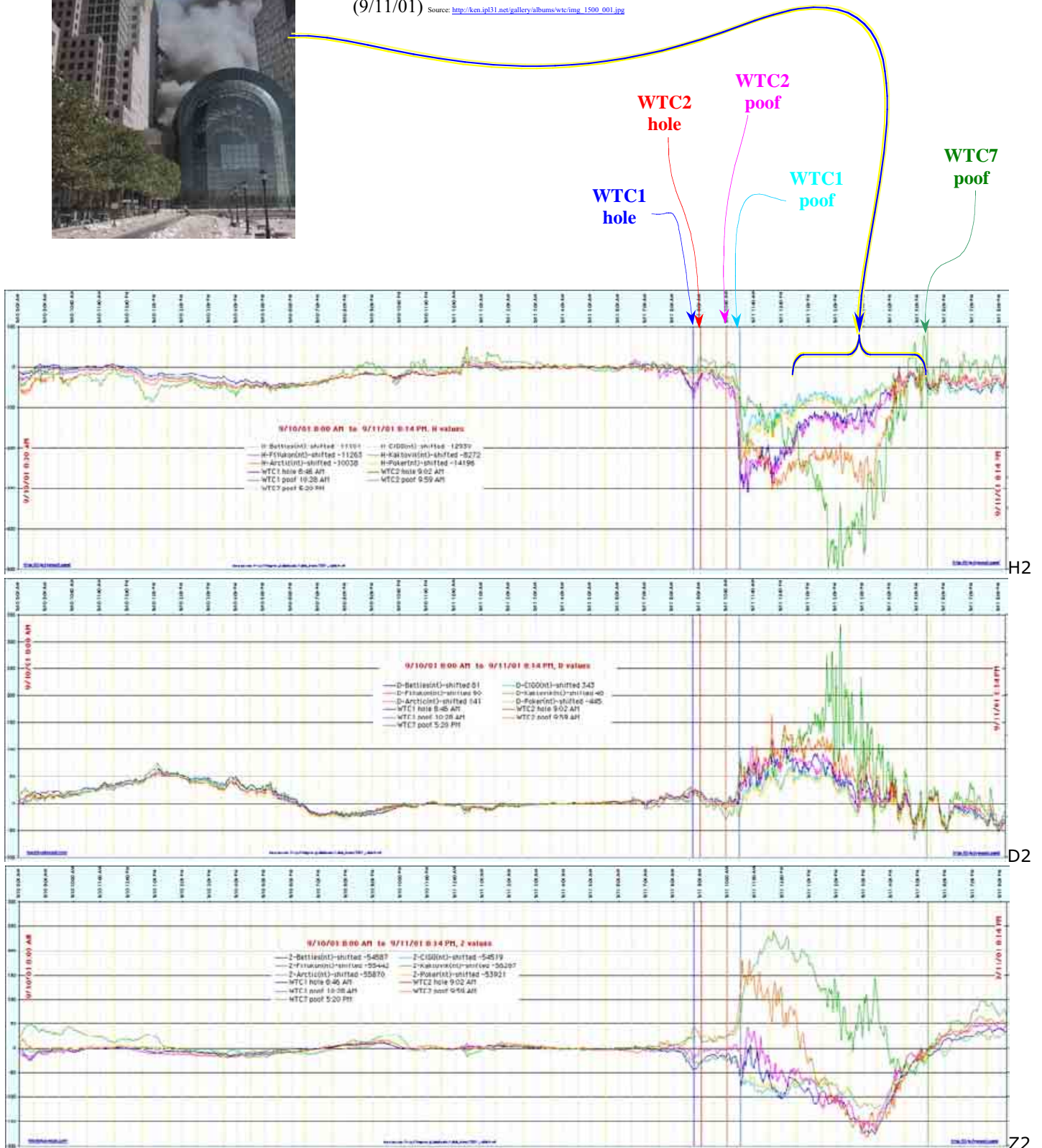

Figure 34. Magnetometer Readings (normalized), 9/10/01-8:00 AM (EDT) - 9/12/01-8:14 PM (EDT)
 (data posted at one-minute intervals)

Source: http://magnet.gialaska.edu/table_index2001_table.html

Comment 16

Issue: Analysis is incomplete; sound analysis omitted.

Location: page 78 of 115 of pdf, (labeled page 40 of report)

http://wtc.nist.gov/media/NIST_NCSTAR_1A_for_public_comment.pdf

3.5.2 Aspects following the Collapse Initiation

Once simulation of the global collapse of WTC 7 was underway, there was a great increase in the uncertainty in the progression of the collapse sequence, due to the random nature of the interaction, break up, **disintegration**, and falling of the debris. The uncertainties deriving from these random processes increasingly influenced the deterministic physics-based collapse process, and the details of the progression of the horizontal failure and final global collapse were increasingly less precise.

Thus, while the two predictions of the time of descent of the west penthouse also straddled the observed time, the mechanisms of building collapse were quite different. In the analysis without debris impact damage, the exterior columns buckled near mid-height of the building, approximately between Floors 17 and 29. In the analysis with debris impact damage, the exterior columns buckled between Floors 7 to 14, due to the influence of the exterior damage near the southwest corner. In both analyses, the eastern exterior wall deflected inward at the roof level as the structure became unsupported after the vertical collapse event. The western wall also deflected inward in the analysis without debris impact damage, as it was pulled inward as the last line of core columns failed.

There was another observable feature that occurred after the global collapse was underway and **no Science-based simulation capability** exists to capture it. After the exterior facade began to fall downward at 6.9 s, the north face developed a line or kink near the end of the core at Column 76. As shown in Figure 5205, the northeast corner then began to displace to the north at about 8.8 s, and the kink was visible at 9.3 s. The kink and rotation of the northeast façade occurred 2 s to 3 s after the exterior façade had begun to move downward, as a result of the global collapse. The simulations do show the formation of the kink, but any subsequent movement of the building is beyond the reliability of the physics in the model.

3.5.3 Accuracy Appraisal

Given the complexity of the modeled behavior, the global collapse analyses matched the observed behavior reasonably well. The close similarity of the timing and the nature of the events up to the initiation of global collapse is strong confirmation of the extent and nature of the structural failures in the interior of the building and the accuracy of the four-step simulation process. The overall simulation of the collapsing building with damage better matched the video observations of the global collapse. The global collapse analysis confirmed the leading collapse hypothesis, which was based on the available evidence.

Figure 35. [**emphasis added**]

page 78 of 115 of pdf, (labeled page 40 of report) http://wtc.nist.gov/media/NIST_NCSTAR_1A_for_public_comment.pdf

Reason for Comment:

Very subjective descriptions of matched observed behavior with the complex nature of the modeled behavior. Any sound simulations compared to observed data as noted in Comment 5.

Analysis incomplete – sound analysis omitted.

Precise measurements should be provided from modeling to compare with actual observations. Sound simulation findings and comparisons to expectations and observable data should be included.

Re-analysis, including sound, needs to be added.

Suggestion for Revision:

NIST has found [insert analysis of soundtrack and other data of audible phenomena].

[It is known that soundtracks show a lack of loud audible booms or crashes, something that makes NIST's probable collapse sequence highly doubtful.]

Comment 17

Issue: 242-foot drop?!

Location: page 79 of 115 of pdf, (labeled page 41 of report)
http://wtc.nist.gov/media/NIST_NCSTAR_1A_for_public_comment.pdf

The elevation of the top of the parapet wall was +925 ft 4 in. The lowest point on the north face of WTC 7 visible on the Camera 3 video (Section 5.7.1) prior to any downward movement was the top of the windows on Floor 29, which had an approximate elevation of +683 ft 6 in. Thus, the distance that the roof-line moved downward before it disappeared from view was 242 ft. The relative time at which the roofline began to descend was 20.60 s, and the relative time when the **roofline dropped from view** behind the buildings was 25.97 s. The time the roofline took to fall 18 stories was 5.4 s, with an uncertainty of no more than 0.1 s.

Figure 36. [emphasis added]
page 79 of 115 of pdf, (labeled page 41 of report) http://wtc.nist.gov/media/NIST_NCSTAR_1A_for_public_comment.pdf

Reason for Comment:

Descent of Roofline by 242 feet should have made a noise.
242 feet of drop noted in evaluation of Camera 3 with no notation of sound-- a very loud noise. Re-analysis, including sound, needs to be added. Analysis of sound as it compares to the visible data in the camera view should be included and compared with expected results.

Suggestion for Revision:

NIST has analyzed all available soundtracks and could not find sound consistent with the 242 drop referenced here.

Or, in the alternative,

The sound of the 242' drop was confirmed by [insert confirming data]

Comment 18

Issue: Incongruence in Collapse time calculation.

Location: page 79 of 115 of pdf, (labeled page 41 of report),
http://wtc.nist.gov/media/NIST_NCSTAR_1A_for_public_comment.pdf

3.6 Collapse Time..... 40

The theoretical time for free fall (i.e., neglecting air friction), was computed from,

$$t = \sqrt{\frac{2h}{g}}$$

where t is the descent time (s), h is the distance fallen (ft), and g is the gravitational acceleration constant, 32.2 ft/s² (9.81 m/s²). **Upon substitution of $h = 242$ ft.** in the above equation, the estimated free fall time for the top of the north face to fall 18 stories was approximately 3.9 s. The uncertainty in this value was also less than 0.1 s.

Thus, the actual time for the upper 18 stories to collapse, based on video evidence, was approximately 40 percent longer than the computed free fall time and was consistent with physical principles.

Figure 37. [emphasis added]
page 79 of 115 of pdf, (labeled page 41 of report), http://wtc.nist.gov/media/NIST_NCSTAR_1A_for_public_comment.pdf

Reason for Comment: NIST arbitrarily limited its collapse time analysis to the 242-foot drop. However, even in doing that, NIST did not correlate its collapse time calculation with either an explanation of what materials dropped [columns, beams, and girders, and their dimensions] and the known audible data and seismic data. The data presented by NIST in Table B-2 shows a dominant period lasting 0.8 seconds.

Collapse time
Duration of signal

Did the ground shake like raining dump trucks?

Table B-2. Major seismic events previously reported.

Event Source	Event Time (EDT)			Table 5-1 of Chapter 5 of This Report (± 1 s) ^b	Equivalent earthquake Magnitude (Richter Scale, ± 0.1)	Dominant Period (s)	Sustained Signal Duration (s)
	ID	Kim et al., 2001	LEDO current Estimate ^a				
WTC 1 impact	1	8:46:26	08:46:29 \pm 2	8:46:30	0.9	0.8	14 \pm 2
WTC2 impact	2	9:02:54	09:02:57 \pm 4	9:02:59	0.7	0.6	6 \pm 2
WTC 2 collapse	3	9:59:04	09:59:07 \pm 2	9:58:59	2.1	0.8	10 \pm 1
WTC 1 collapse	4	10:28:31	10:28:34 \pm 2	10:28:22	2.3	0.9	9 \pm 1
WTC 7 collapse	5	17:20:33	17:20:42 \pm 4	17:20:52 ^c	0.6	0.8	17 \pm 2 ^d

a derived from signal arrival and estimated travel times from WTC site to PAL

b based upon events observed in videos and photographs; collapse times were based on collapse initiation, not time of ground impact

c NCSTAR 1-5A timing was based on downward movement of the WTC 7 roofline and not the downward movement of the east penthouse that occurred earlier.

d Total duration of BHE PAL signal in Fig. A-6, including a possible second arrival

Figure 38.

page 316 of 382 of pdf, (labeled page 654 of report) http://wtc.nist.gov/media/NIST_NCSTAR_1-9_vol2_for_public_comment.pdf

NIST does not correlate with the seismic data noted . That data shows a seismic event lasting less than 6.4 seconds.

$$t = \sqrt{\frac{2h}{g}}, \text{ where } h = 650 \text{ ft} (198 \text{ m}), 32.2 \text{ ft/s}^2 (9.81 \text{ m/s}^2),$$

$$t = 6.355 \text{ seconds, or } t = 6.4 \text{ s.}$$

The collapse time for the building is not addressed. Analysis is incomplete and inconsistent with time the ground shook. Add: the sound heard should have been comparable with a fleet of dump trucks crashing to the ground (one only has to consider the noise and vibration of one that is loaded when it passes by a pedestrian on the sidewalk). In complete and should be addressed.

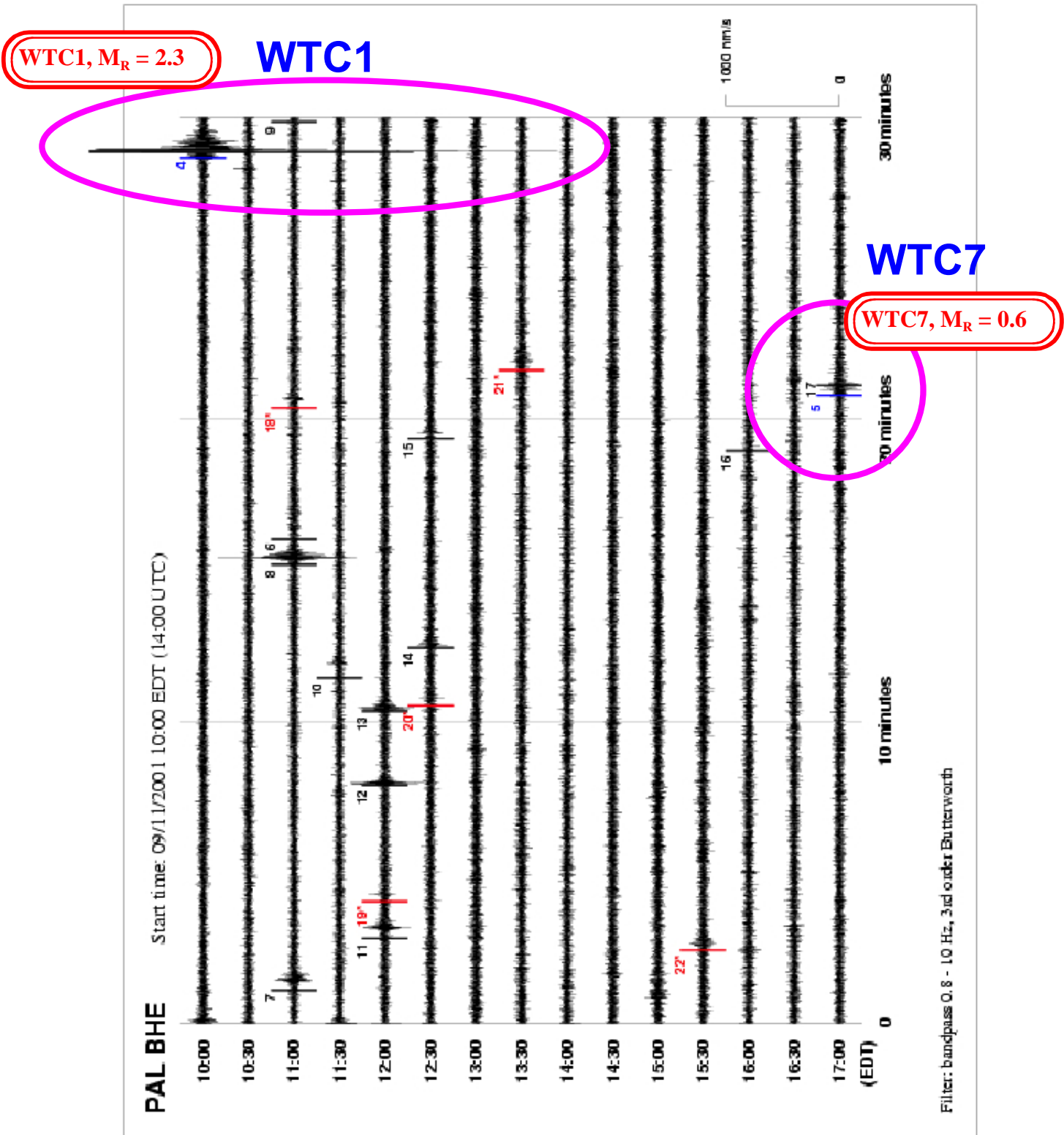

Figure B-9. Events identified on PAL seismogram.
Refer to Table B-4 for location, strength and description of event type.

Figure 39.

329 of 382 of pdf, (labeled page 667 of report) http://wtc.nist.gov/media/NIST_NCSTAR_1-9_vol2_for_public_comment.pdf

$$T = \sqrt{(2 \cdot h)/g} = \sqrt{(2 \cdot 650)/32.2} = 6.3539 \text{ seconds} \approx \sim 6.4 \text{ seconds.}$$

Vertical-component seismic signals generated by WTC building 7 collapse
 09/11/2001, 17:20:42 (EDT), 40.714°N, 74.012°W, Bandpass filter: 0.6-5 Hz

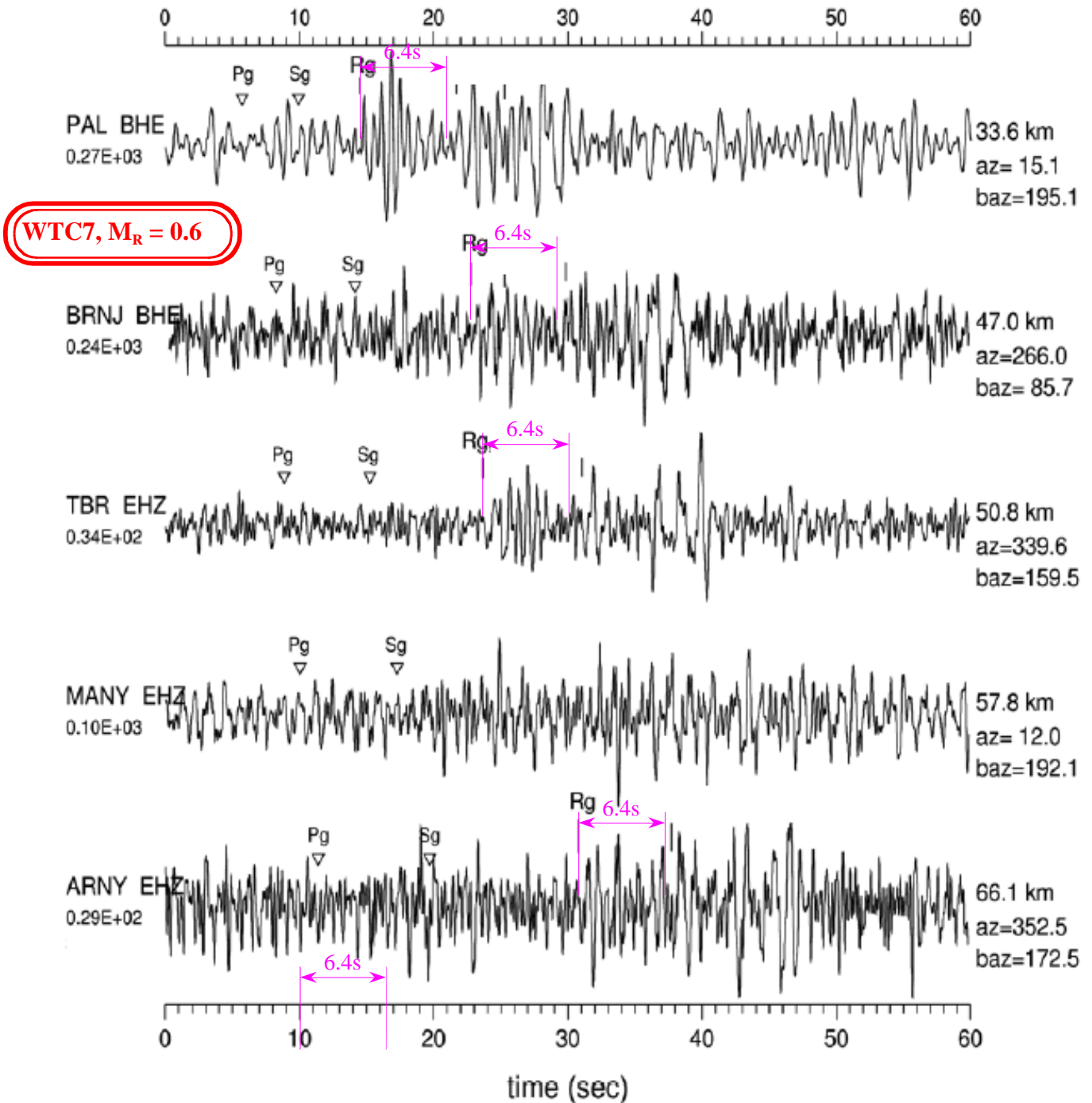

Figure B-5. East-west (BHE) and vertical (EHZ) component seismic records, 0.6 Hz filtered, at PAL, BRNJ, TBR, MANY and ARNY from collapse of WTC 7.

Figure 40.

page 320 of 382 of pdf, http://wtc.nist.gov/media/NIST_NCSTAR_1-9_vol2_for_public_comment.pdf
 (labeled page 658 of report)

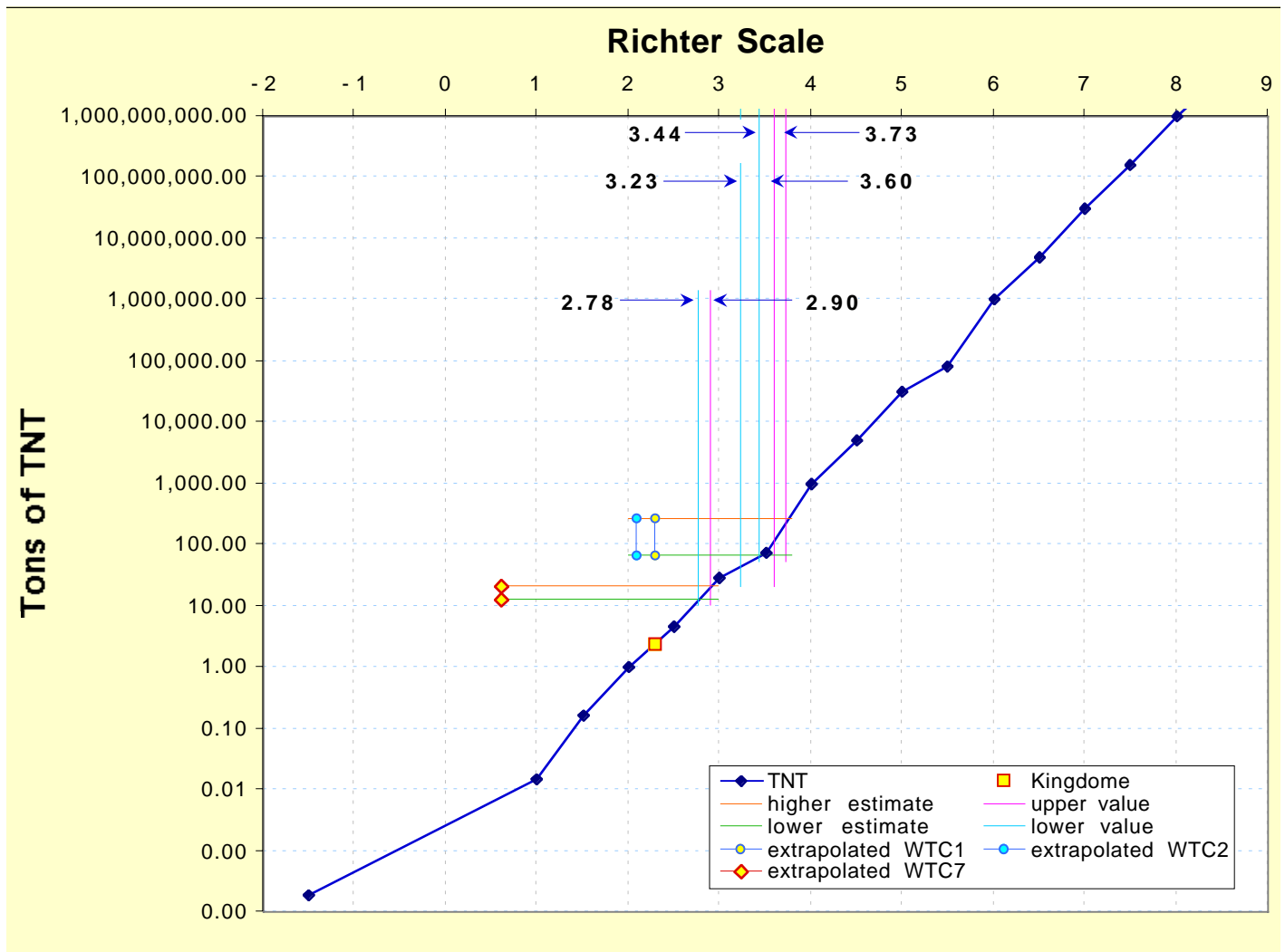

Figure 41.

Suggestion for Revision:

Comment 19 The analysis of sound is incomplete.

Issue: Selective use of audible data

Location: page 87 of 115 of pdf, (labeled page 49 of report),
http://wtc.nist.gov/media/NIST_NCSTAR_1A_for_public_comment.pdf

Hypothetical blast events did not play a role in the collapse of WTC 7. NIST concluded that blast events could not have occurred, and found no evidence whose explanation required invocation of a blast event. Blast from the smallest charge capable of failing a critical column (i.e., Column 79) would have resulted in a sound level of 130 dB to 140 dB at a distance of at least half a mile if unobstructed by surrounding buildings (such as along Greenwich Street and West Broadway). **This sound level is comparable to a gunshot blast, standing next to a jet plane engine, and more than 10 times louder than being in front of the speakers at a rock concert.** The sound from such a blast in an urban setting would have been reflected and channeled down streets with minimum attenuation. **However, the soundtracks from videos being recorded at the time of the collapse did not contain any sound as intense as would**

have accompanied such a blast.

Figure 42. [emphasis added]

page 87 of 115 of pdf, (labeled page 49 of report), http://wtc.nist.gov/media/NIST_NCSTAR_1A_for_public_comment.pdf

5.7.5 Audio Characteristics Based on Video Soundtracks

Three videos in the database included soundtracks that were used to investigate the audio signature associated with the period immediately prior to and during the collapse of WTC 7. All of these cameras were located at street level at least 640 m (2100 ft) from the building. Also, there were numerous other buildings between the cameras and WTC 7.

The most usable soundtrack was recorded by Camera 3, with its West Street location. This video ran for many minutes **prior to and during** the collapse. **Even though sound was recorded by the camera, no interviews or commentary were recorded, and the microphone tended to pick up low level street sounds, such as sirens, traffic, and distant conversations.** Occasionally, the camera operators located nearby were recorded at a much louder level. Since the collapse was recorded on the video, it was possible to coordinate the sound recording with the actual WTC 7 collapse.

A careful review of the audio clip **did not reveal any sounds that could be associated with WTC 7 until the global collapse began.** A low level waveform for the audio signal using Aftereffects software. This video also did not reveal **any features that could be associated with the collapse until after the global collapse began.** In the analysis, the roughly 2 s delay in sound transmission between WTC 7 and the camera was accounted for. The amplitude of the sound signal increased while the global collapse was taking place, **but there were no loud, explosive sounds when the collapse began.**

The response of the camera operators provides another indication of the audio environment. **Even though the east penthouse began to descend into the building 6.9 s prior to initiation of global collapse, there was no verbal response from the camera operators until 2.5 s after the global collapse began, when a loud shout of whoa, whoa, whoa was heard.** There is no evidence that the operators heard something that attracted their attention prior to this time.

At the same time the Camera 3 video was being shot, a recorded street interview was being conducted a short distance away on West Street. In this video clip of the interview, WTC 7 is visible in the upper left hand corner of the frame. Even though the east penthouse can be seen disappearing into the building, neither the camera operator, interviewer, nor interviewee responded in any way until just over 3 s after the global collapse began. Again, there was no indication that sounds loud enough to attract attention or cause alarm were heard by people at the interview location prior to global collapse initiation.

Figure 43. [emphasis added]

Page 333-334 of 404 of pdf, (labeled page 289-290 of report) http://wtc.nist.gov/media/NIST_NCSTAR_1-9_Vol1_for_public_comment.pdf

Reason for Comment: The sound analysis is incomplete. It is stated that the soundtracks from the videos recording the event did not contain any sound as intense as would have accompanied such a blast, yet there is no analysis for what sound levels should accompany the sudden gravity collapse proposed. Sound is used as one of the criteria to eliminate the consideration of a blast event as causing the destruction of WTC7. But the proposed causal theory with a gravity collapse has not been tested by the same criteria.

WTC7 is approximately 200,000 tons. That's equivalent in mass to about 10,000 - 20,000 dump trucks, distributed in space over the height of the building. If those suddenly collapsed to the ground, the sound should be audible, should register seismically and must be included in NIST's analysis.

NIST acknowledges that it did not do an analysis of the soundtracks in order to verify its collapse hypothesis and, instead, only used soundtrack analysis to confirm there was no loud sound that would have been expected from a hypothetical blast event. NIST is aware that its work in this respect may be challenged as being fraudulent.

Suggestion for Revision:

Soundtrack analysis data show [add data] and add conclusions that follow from that data.

10 - 20 tons (including some cargo)



Comment 20

Issue: Eliminating Controlled Demolition through false choice.

Location: Page 345-6 of 382 of pdf, (labeled page 683-4 of report), http://wtc.nist.gov/media/NIST_NCSTAR_1-9_vol2_for_public_comment.pdf

D.2 PHASE I: EXPERT RECOMMENDED PREPARATIONS FOR EXPLOSIVELY CONTROLLED DEMOLITION

Phase I identified a single minimum plausible scenario for the **explosive** demolition of a selected column or truss. This included columns that supported large tributary areas and a critical truss cross-member. The analysis assumed that severance of one of these members could initiate building collapse. For successful demolition of a column, failure was defined as complete severance of the column section, or complete severance of sufficient sections of the flange, web, and cover plates, such that the remaining column section was insufficient to carry the column service loads, or that a lateral deflection of the column section would exceed its section width.

The hypothetical blast scenarios that were addressed fell into two categories:

Those in which there was sufficient time to prepare the structures for an optimum setup prior to demolition. The objective would have been to use the minimum possible amount of explosives in the demolition process. Preliminary cutting of structural members could have been performed.

18. Those in which the demolition was to be performed in the shortest possible time. The objective would have been to set up for demolition during approximately a 6 h time frame, i.e., between the time WTC 7 had been evacuated and the time at which collapse occurred.

For each of the scenario categories, the type and quantity of explosive material (e.g., shaped charges, C4 or other **nondirectional** explosive materials) required to fail each of the selected column sections was identified. In addition, any special equipment or supplies, and the time required to prepare the column, were identified. For each scenario, expected secondary effects fireballs, noise level, extent of window breakage, and dust expulsion were estimated. Two

approaches were considered, in which the column was or was not prepared with preliminary cutting..

Figure 44. [emphasis added]

Page 345-6 of 382 of pdf, (labeled page 683-4 of report), http://wtc.nist.gov/media/NIST_NCSTAR_1-9_vol2_for_public_comment.pdf

Reason for Comment: False choice. Only a particular type of "controlled demolition" was ruled out, which is **conventional-controlled demolition** with **bombs in the building** (CCD-BiB). This is a false choice ...

All that was considered is the following two categories:

- a) Those in which there was sufficient time to prepare the structures for an optimum setup prior to demolition.
- b) Those in which the demolition was to be performed in the shortest possible time.

Other evidence now available suggests some sort of high-tech weaponry was used.

Erin, field effects



Figure 45. This is called "dry thunder."

http://www.flatrock.org.nz/topics/environment/assets/tornado_and_lightning.jpg



Figure 46. Hurricane in Toronto, Canada, October 9-12, 2007. (10/9-12/07)

<http://fastestgame.files.wordpress.com/2007/10/hurricane.jpg>

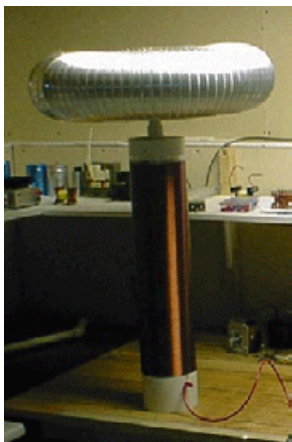

Figure 47. A Tesla coil

http://hackedgadgets.com/wp-content/tesla_coil.gif

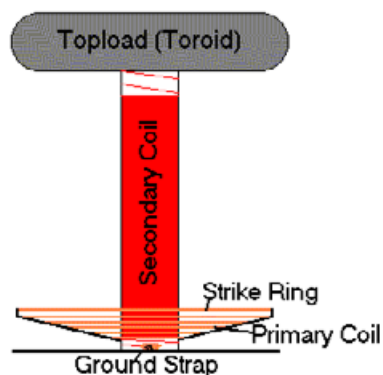

Figure 48. Diagram of a Tesla coil

<http://www.powerlabs.org/images/tdcraw.gif>

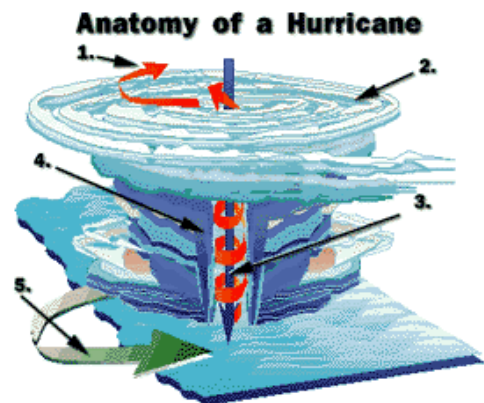

Figure 49.

http://img.cosnewsweb.com/B.01/56/62/image_62361.gif%20http://www.palmbeachpost.com/storm/content/storm/about/anatomy.html

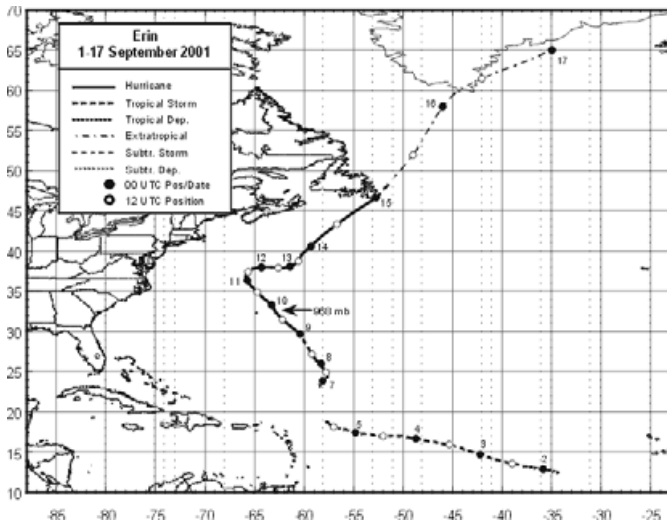

Figure 50. Best track for Hurricane Erin, September 2001. Track during the extratropical stage is based on analyses from the NOAA Marine Prediction Center. (Original figure from source.) <http://www.nhc.noaa.gov/2001erin.html>

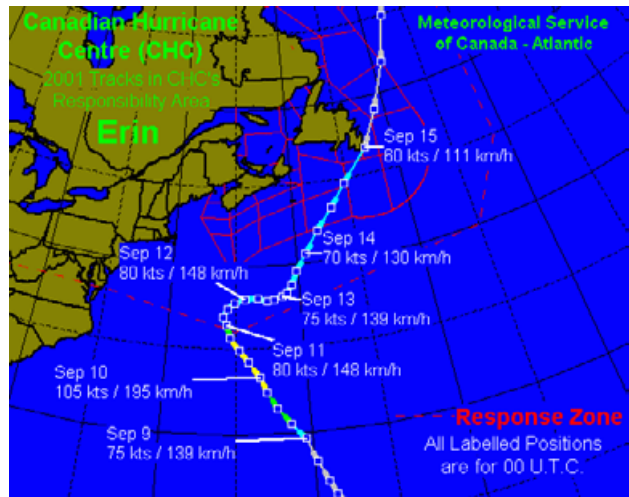

Figure 51. Hurricane Erin track (atl.ec.gc.ca). According to the Canadian Hurricane Centre (CHC), Hurricane Erin entered the "Response Zone." A hurricane in this zone should presumably trigger a "response." http://www.atl.ec.gc.ca/weather/hurricane/images/2001/erin2001_e.gif



Figure 52. <http://memory.loc.gov/service/pnp/ppmsca/02100/02102v.jpg>



Figure 53. Note, the fence still stands. <http://img503.imageshack.us/img503/7780/dsc07405fu.jpg>

Weather and Magnetometer Data

Space Weather

The following four charts (Figures 54 to 57) show that there were no solar storms or other significant space-weather events.

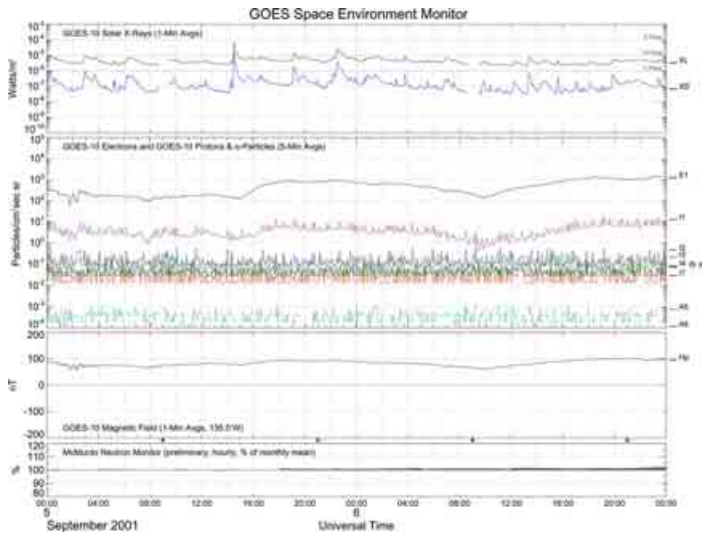

Figure 54. Space weather, 9/5/01-9/6/01

<http://goes.nedc.noaa.gov/data/plots/2001/GOES-200109.pdf>, [GOES-20010904_150.jpg](http://goes.nedc.noaa.gov/data/plots/2001/GOES-20010904_150.jpg)

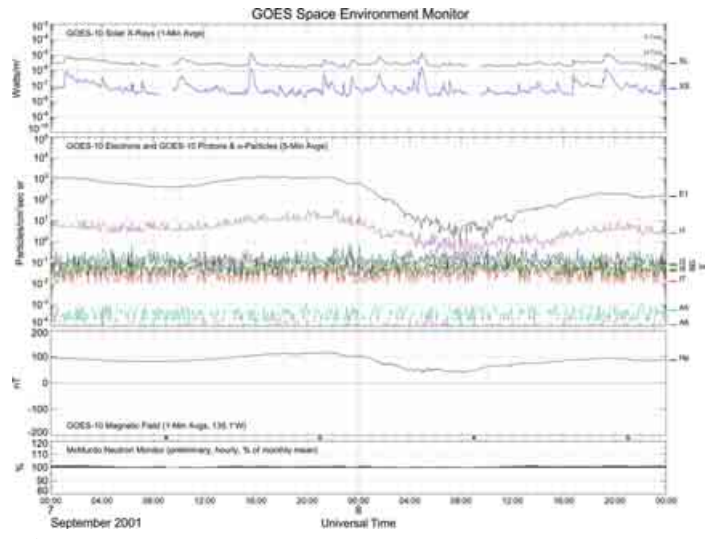

Figure 55. Space weather, 9/7/01-9/8/01

<http://goes.nedc.noaa.gov/data/plots/2001/GOES-200109.pdf>, [GOES-20010905_150.jpg](http://goes.nedc.noaa.gov/data/plots/2001/GOES-20010905_150.jpg)

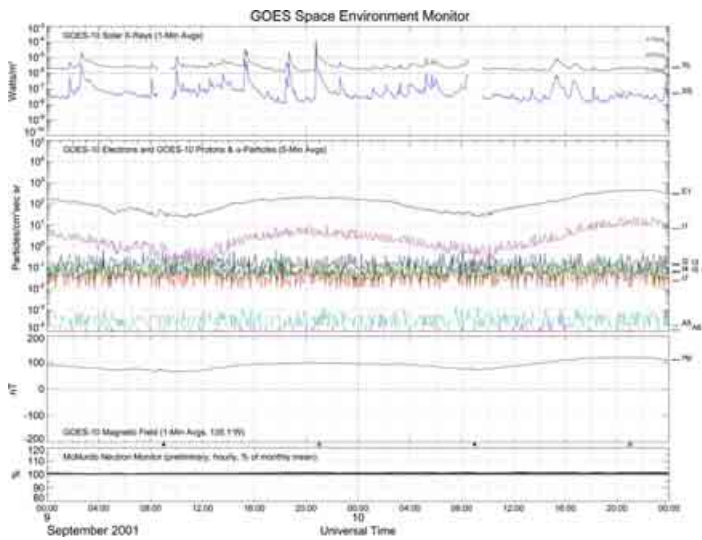

Figure 56. Space weather, 9/9/01-9/10/01

<http://goes.nedc.noaa.gov/data/plots/2001/GOES-200109.pdf>, [GOES-20010906_150.jpg](http://goes.nedc.noaa.gov/data/plots/2001/GOES-20010906_150.jpg)

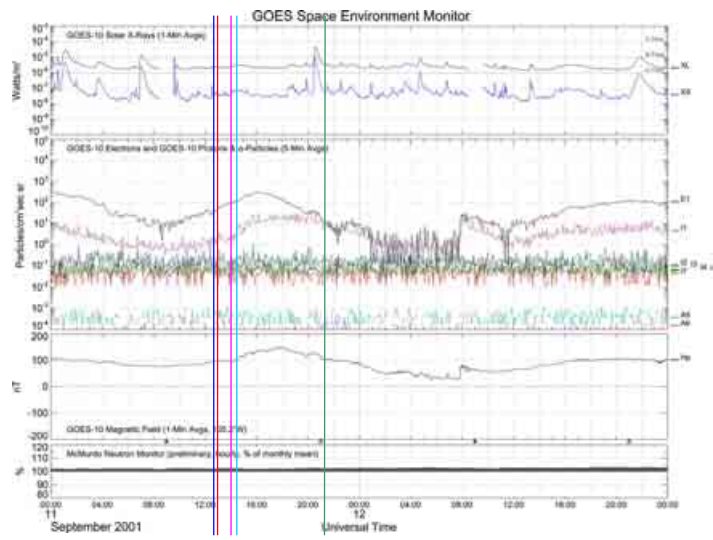

Figure 57. Space weather, 9/11/01-9/12/01

<http://goes.nedc.noaa.gov/data/plots/2001/GOES-200109.pdf>, [GOES-20010907_150.jpg](http://goes.nedc.noaa.gov/data/plots/2001/GOES-20010907_150.jpg)

NHC Data
(9/9/01 - 9/12/01)

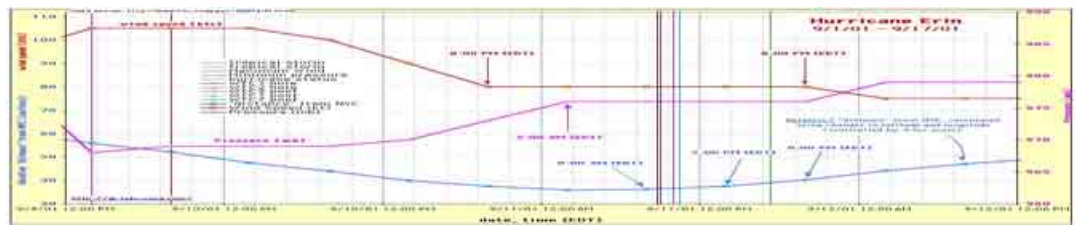

Figure 58. nhc <http://www.nhc.noaa.gov/2001erin.html> , http://drjudywood.com/articles/erin/cpics/2001_erin_close.jpg

Magnetometer Data (9/8/01 - 9/12/01)

Magnetometer Readings (normalized), 6 stations (96 hours), 9/8/01-8:00 PM (EDT) - 9/12/01-8:00 PM (EDT)
 (data posted at one-minute intervals)



Figure 59. H1 http://magnet.gi.alaska.edu/table_index/2001_table.html

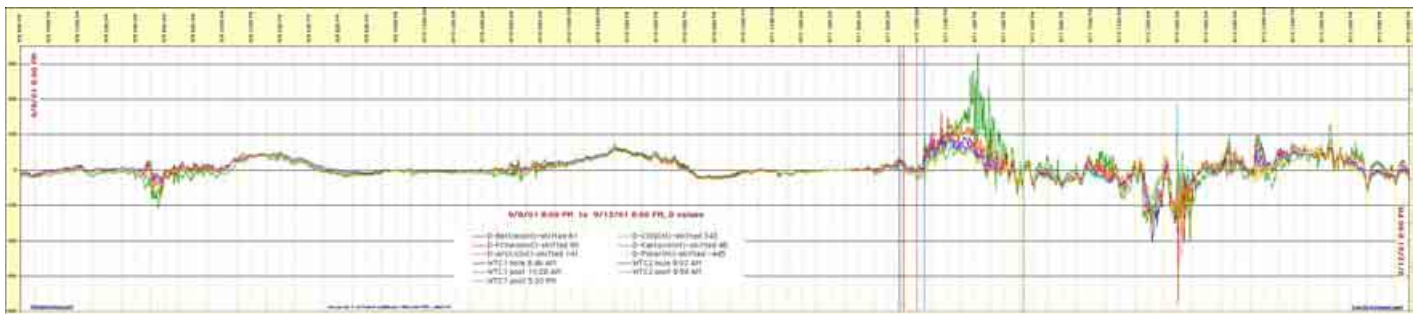

Figure 60. D1 http://magnet.gi.alaska.edu/table_index/2001_table.html

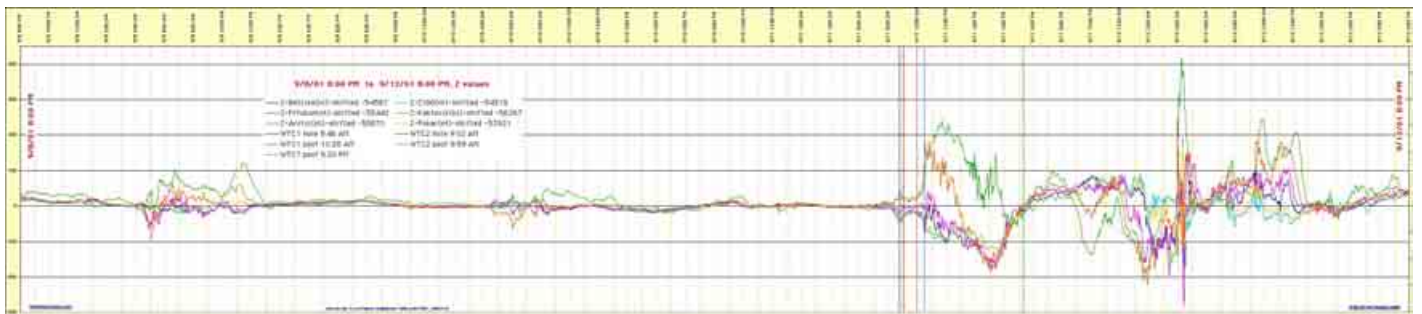

Figure 61. Z1 http://magnet.gi.alaska.edu/table_index/2001_table.html

WTC1 hole
 WTC2 hole
 WTC1 poof
 WTC2 poof
 WTC7 poof

NHC Data
 (9/9/01 - 9/12/01)

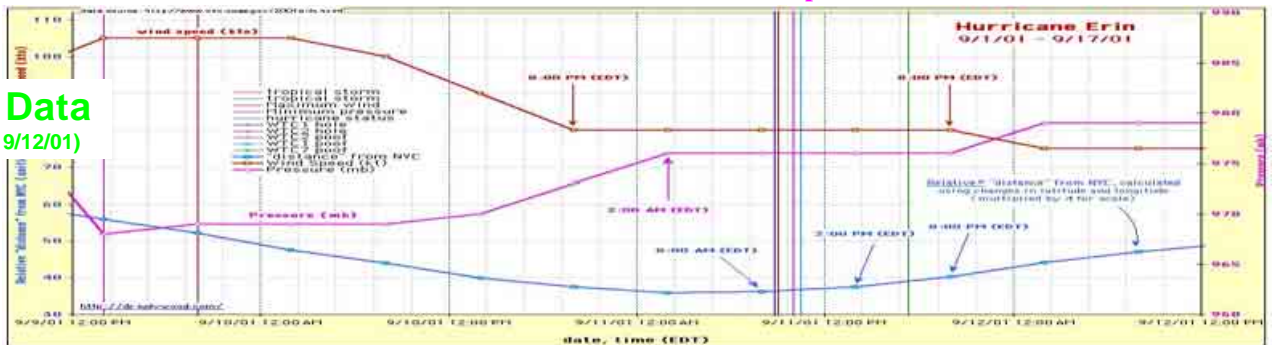

Figure 62. nhc <http://www.nhc.noaa.gov/2001erin.html>, http://drjudywood.com/articles/erin/cpics/2001_erin_close.jpg

Suggestion for Revision:

Inclusion of additional data and analysis which illustrates use of high tech weaponry.

Comment 21

Issue: Need to explain "disintegration."

Location:

The uncertainties in predicting the precise progression of the collapse sequence increased as the analysis proceeded due to the random nature of the interaction, break up, **disintegration**, and falling of the debris. The uncertainties deriving from these random processes increasingly influence the deterministic physics-based collapse process. Thus, the details of the progression of horizontal failure and final global collapse were sensitive to the uncertainties in how the building materials (steel, concrete) and building systems and contents interacted, broke up, and **disintegrated**

Figure 63. [emphasis added]

page 89 of 115 of pdf, (labeled page 51 of report) http://wtc.nist.gov/media/NIST_NCSTAR_1A_for_public_comment.pdf

Reason for Comment:

The use of the word *disintegration* of building materials in the text should be described. Material volumes of the debris pile would indicate that much of the building mass was in fact disintegrated to the point that it blew away in the form of dust.

By NIST's own admission, the modeling is an approximation only. While it may simulate some observed features of the destruction, it does not explain the resulting status of Building 7. NIST limited its analysis of hypothetical blast events that are not only nonexhaustive, they are, indeed, extremely limited. NIST is informed that its work in this respect will be challenged as being fraudulent.

Full analyses of the mass remaining in the debris pile should be compared with expected mass and corresponding volume considering the amount of steel and concrete. That very little intact concrete existed in the debris pile and the unusual organization of the steel that remained in the pile should be documented and modeled. That the word *disintegration* was used in this context, full descriptions should be made and any variances from expected mass and volume of debris remaining should be explained. The report should explain how it is that surrounding buildings were not damaged or the fact that debris in the pile did not even cross the streets, fully remaining within a few feet of the footprint of the building itself. New analyses are required which explain resulting debris pile as well as speed and nature of destruction. Also, sound analysis required.

NIST's acknowledgment of disintegration of steel columns, beams and girders that are as massive as those contained in WTC 7 is both accurate, as to what actually happened, and simultaneously, a description of an event that is inconsistent with office fires. Hence, a more complete explanation of how disintegration of so much massive material could have occurred is mandatory.

Suggestion for Revision:

NIST has no current explanation for the disintegration it acknowledges occurred. NIST understands that its failure to do so may be a part of the basis for a claim of fraud that will be filed by Dr. Judy Wood.

Comment 22

Issue: Effects on WTC7 compared with effects on Bankers Trust

Location: Page 82-4 of 404 of pdf (labeled page 38-40 of report),

http://wtc.nist.gov/media/NIST_NCSTAR_1-9_Vol1_for_public_comment.pdf

After Debris Impact

After the dust and smoke cleared following the collapse of WTC 1, damage to WTC 7 was observed primarily on the south face near the southwest corner, between Floors 5 to 17 (Section 5.5). Seven

Comment: 20 with 6 pages

exterior columns were severed (six columns on the south face and one column on the west face). The interior damage was not visible but, based on engineering judgment and interview accounts by individuals that were in or around WTC 7, estimates of interior structural damage between the exterior walls and the core were made. Chapter 5 describes the damage observed from photos and videos, and the structural damage in the southwest region is summarized in Section 5.5.3.

The WTC 7 structural damage resulted from debris falling from WTC 1. In a similar fashion, the building located at 130 Liberty Street (referred to as Deutsche Bank or the Bankers Trust building), was damaged by falling exterior panels from WTC 2 as it collapsed. NIST was granted access to inspect floors where damage occurred in the building on 130 Liberty Street on August 21 and 22, 2006. The debris from WTC 2 had penetrated the north face of the 130 Liberty Street building and caused damage to Floors 9 through 22, as shown in Figure 2-30 and Figure 2-31. The north face had severed spandrel beams between exterior columns, with the damage extending into the interior that grew in magnitude as the debris fell. Figure 2-31 shows that the floor beams framing into intact exterior columns remained in place, but the SFRM in the immediate vicinity of the damage was knocked off.

Figure 2-32 shows the extent of the damage that was documented by the FEMA WTC Building Performance Study (McAllister 2002). Immediately after the damage was incurred, the ceilings and column enclosures were still in place, so possible SFRM damage in other parts of the building could not be observed.

Figure 64. [emphasis added]

Page 82 of 404 of pdf (labeled page 38 of report), http://wtc.nist.gov/media/NIST_NCSTAR_1-9_VolI_for_public_comment.pdf



NIST photograph 2006.

Figure 2–30. Exterior view of damage to the north face of 130 Liberty Street by debris falling from WTC 2.



NIST photograph 2006.

Figure 2–31. Interior view of damage to the north face of 130 Liberty Street by debris falling from WTC 2.

Figure 65. Page 83 of 404 of pdf (labeled page 39 of report), http://wtc.nist.gov/media/NIST_NCSTAR_1-9_VolI_for_public_comment.pdf

Figure 66. Page 84 of 404 of pdf (labeled page 40 of report), http://wtc.nist.gov/media/NIST_NCSTAR_1-9_VolI_for_public_comment.pdf

Reason for Comment:

It was assumed that falling debris caused the damage in Bankers Trust, but the evidence is not consistent with this conclusion. There has not been a full investigation of the damage to Bankers Trust. There is little debris visible in the open "gash." There is a recognizable "wheatchex" (a unit of three outer columns, three stories tall) presumably from WTC2. This "wheatchex" does not exhibit the level of damage even tool steel might have if grinding out the amount of material that is missing. The damage in Bankers Trust is consistent with molecular

dissociation resulting from the use of an energy weapon. This information has been presented to NIST (2/29/08), previously, including the continuing reaction implies that this effect is non-self-quenching, exposing the public to continuing danger. In that correspondence, I noted that "[t]he destruction of WTC7 exhibited nearly all of the same characteristics as the destruction of WTC1&2. Noting that many of the contractors are the same, so it is likely that NIST's ongoing investigation of WTC7 may be dangerously and fraudulently flawed to such a degree that if it is not halted and if the current contractors are not removed, then the problems associated with the cover-up of the fact that the World Trade Center was destroyed by directed energy weapons may continue to multiply." The original correspondence is attached here. [FletcherMcAllister.pdf] [080229_AFFIDAVITtight.pdf]

According to FEMA, there were no fires in this building.

6 Bankers Trust Building

6.1 Introduction

The Bankers Trust building at 130 Liberty Street, also referred to as the Deutsche Bank building, withstood the impact of one or more pieces of column-tree debris raining down from the collapsing south tower (WTC 2). Although the debris sliced through the exterior façade, fracturing spandrel beam connections and exterior columns for a height of approximately 15 stories, the building sustained only localized damage in the immediate path of the debris from WTC 2 (hereafter referred to as the impact debris) (Figures 6-1 and 6-2).

There were no fires in this building. [emphasis added] The ability of this building to sustain significant structural damage yet arrest the progression of collapse is worthy of thorough study. Unlike WTC 1, 2, and 7, which collapsed completely, the Bankers Trust building provided an opportunity to analyze a structure that suffered a moderate level of damage, to explain the structural behavior, and to verify the analytical methods used. The following sections describe the building structure, the extent of damage, and the computational methods that were used to analyze the structure.

6.2 Building Description

The Bankers Trust building is a steel-frame commercial office structure, designed and constructed circa 1971. Bankers Trust was designed by Shreve, Lamb & Harmon Associates P. C. Architects; Peterson and Brickbauer Associated Architects; the Office of James Rudderman Structural Engineers, and Jaros Baum and Bolles Mechanical and Electrical Engineers. The building measures 560 feet in height with 40 stories above grade and 2 below. It is located directly across Liberty Street from the former site of WTC 2, about 600 feet due south of the southeast corner of WTC 2.



Figure 6-1
North face of Bankers Trust building with Impact damage
between floors 8 and 23.

Photo credit: FEDERAL EMERGENCY MANAGEMENT AGENCY

Figure 67. Page 1 of 16 of pdf (labeled page 6-1 of FEMA report), http://www.fema.gov/pdf/library/fema403_ch6.pdf

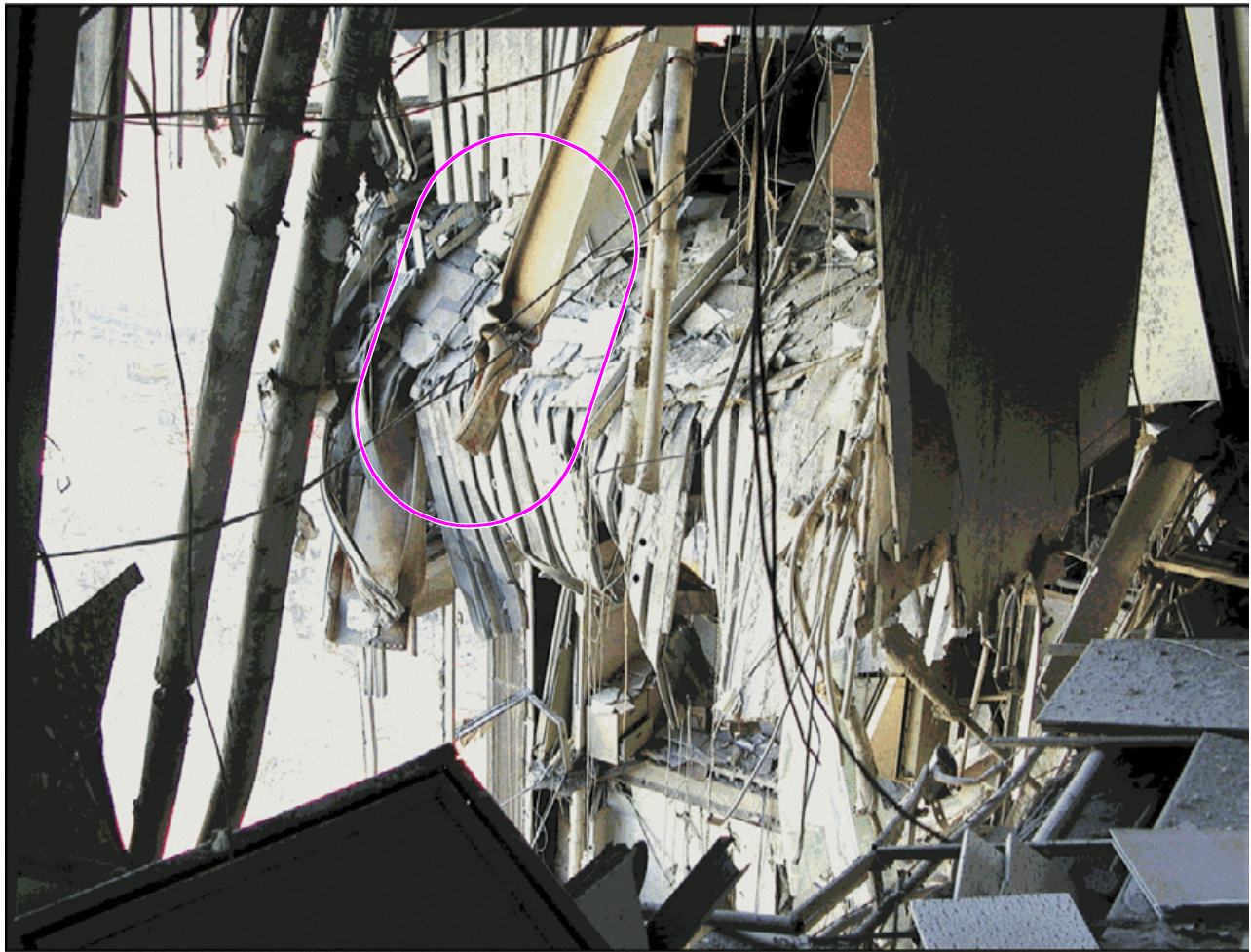
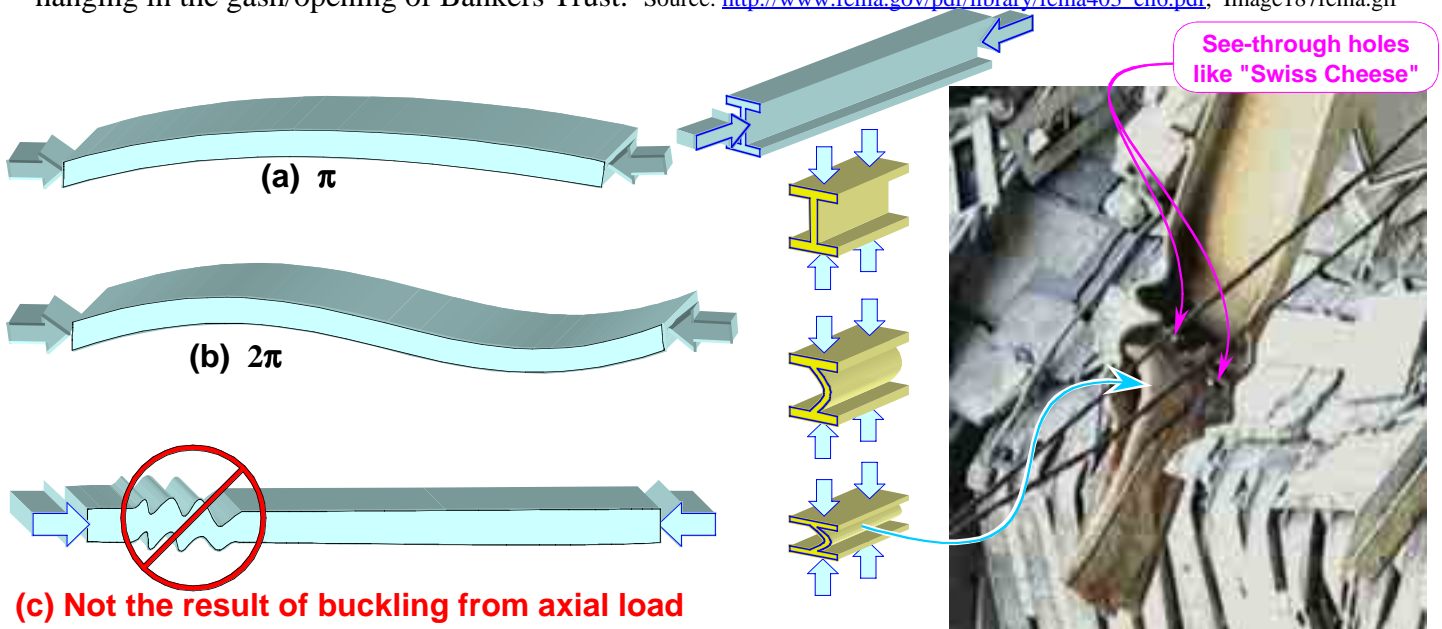

Figure 6-10 Area of collapsed floor slab in bays between C-8, E-8, C-7, and E-7, from the 15th floor.

Figure 68. (Fig6-10.) from the FEMA report . This beam shriveled up and has see-through holes in it, hanging in the gash/opening of Bankers Trust. Source: http://www.fema.gov/pdf/library/fema403_ch6.pdf, Image187fema.gif



(c) Not the result of buckling from axial load

Figure 69. In buckling a beam deforms into (a) a half sine wave, π , or (b) a full sine wave, or 2π . The random deformation in (c) is not associated with buckling.

Figure 70. A close-up view of an I-beam in Figure 68.

Source: http://www.fema.gov/pdf/library/fema403_ch6.pdf, FEMA6-10_ccc.jpg



Figure 71. Figure 6-8, Failed shear connection of beam web to column web.
Page 8 of 16 of pdf (labeled page 6-8 of FEMA report),
http://www.fema.gov/pdf/library/fema403_ch6.pdf
fema403_ch608p8a.jpg

This steel connection from Banker's Trust is very deteriorated.

Suggestion for Revision:

NIST acknowledges that its comparison of effects on WTC 7 with those occurring to the Bankers Trust building may be challenged as being fraudulent by Dr. Judy Wood.

Comment 23

Issue: Modeling a disintegrating structure

Location: page 108 of 170 of pdf (labeled page 56 of report), http://wtc.nist.gov/media/NIST_NCSTAR_1-9A_for_public_comment.pdf

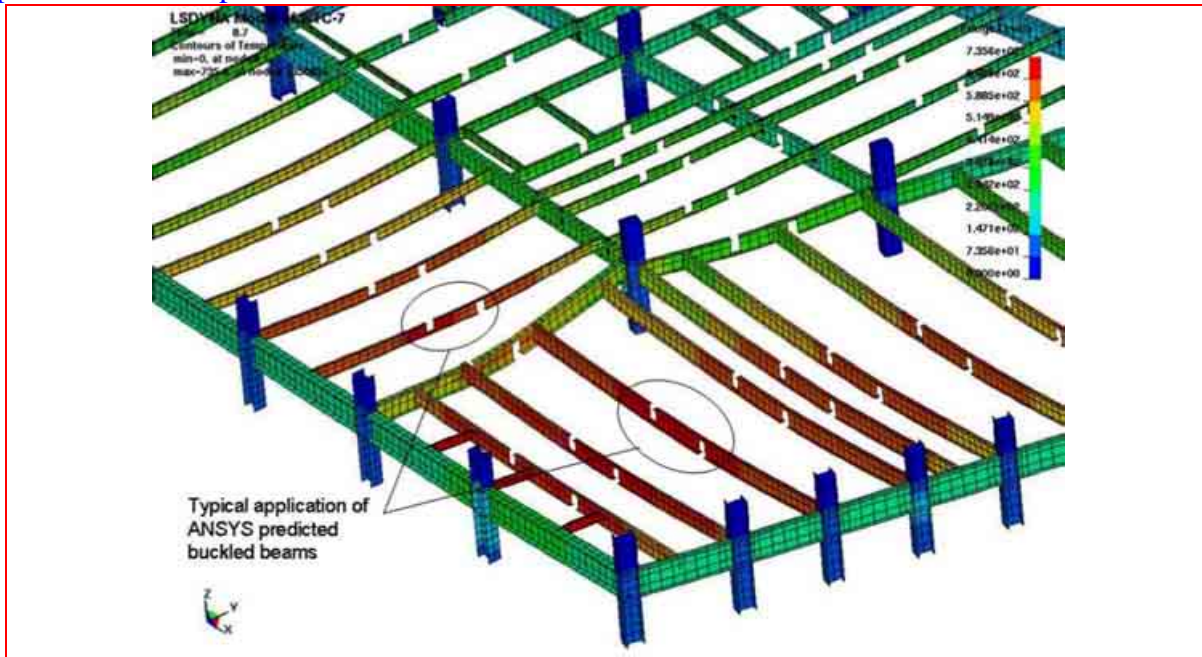

Figure 72.

page 108 of 170 of pdf (labeled page 56 of report), http://wtc.nist.gov/media/NIST_NCSTAR_1-9A_for_public_comment.pdf

The uncertainties in predicting the precise progression of the collapse sequence increased as the analysis proceeded due to the random nature of the interaction, break up, **disintegration**, and falling of the debris. The uncertainties deriving from these random processes increasingly influence the deterministic physics-based collapse process. Thus, the details of the progression of horizontal failure and final global collapse were sensitive to the uncertainties in how the building materials (steel, concrete) and building systems and contents interacted, broke up, and **disintegrated**

Figure 73. [emphasis added]

page 89 of 115 of pdf, (labeled page 51 of report) http://wtc.nist.gov/media/NIST_NCSTAR_1A_for_public_comment.pdf

Reason for Comment:

Thermal expansion does not cause tensile failure of beams that are expanding with end constraints. This drawing above does not show buckled beams. It shows beams with gaps in them. Apparently this is how ANSYS illustrates buckled beams, representing a reduced stiffness. If the stiffness is reduced, then the force this beam is able to apply on the end connections due to "thermal expansion" is also reduced. That is, if a beam has buckled, the amount of axial force it will apply is greatly reduced. If one beam buckles, it reduces the constraint on neighboring beams, reducing their stress. So, it is difficult to imagine how every beam on one floor could have buckled, as is shown in the diagram above.

If the beams were actually disintegrating, as stated elsewhere in the NIST report, the disintegrating structure could be modeled using "buckled beams." If this is what was done, this should be clearly stated in the report.

Samples of steel apparently recovered from WTC7 show evidence of molecular dissociation from partial disintegration. Some of these are shown in the figures below. The FEMA report implied these came from WTC7.

The "Deep Mystery" of Melted Steel <http://www.wpi.edu/News/Transformations/2002Spring/steel.html>

"Materials science professors Ronald R. Biederman and Richard D. Sisson Jr. confirmed the presence of eutectic formations by examining steel samples under optical and scanning electron microscopes. A preliminary report was published in JOM, the journal of the Minerals, Metals & Materials Society. A more detailed analysis comprises Appendix C of the FEMA report. The New York Times called these findings 'perhaps the deepest mystery uncovered in the investigation.' The significance of the work **on a sample from Building 7** and a structural column from one of the twin towers becomes apparent only when one sees these heavy chunks of damaged metal."



Figure 74. This piece of steel thought to be from WTC7 appears partially disintegrated. (Figure C-2. Closeup view of eroded wide-flange beam section.) (2002) Source: http://www.fema.gov/pdf/library/fema403_apc.pdf



Figure 75. This piece of steel thought to be from WTC7 appears partially disintegrated. (Figure C-1. Eroded A36 wide-flange beam.) (2002) Source: http://www.fema.gov/pdf/library/fema403_apc.pdf

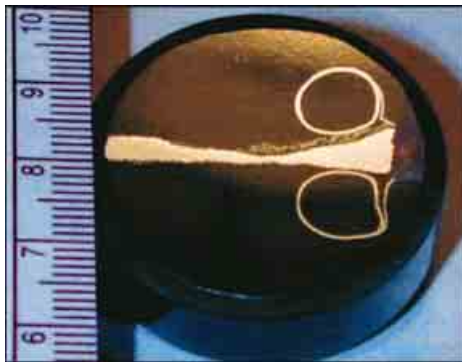

Figure 76. This piece of steel thought to be from WTC7 appears partially disintegrated. (Figure C-3. Mounted and polished severely thinned section removed from the wide-flange beam shown in Figure C-1.) (2002) Source: http://www.fema.gov/pdf/library/fema403_apc.pdf



Figure 77. "A Beam Removed From the World Trade Center the Site Most Probably From Building 7" (Ref: Astaneh-Asl, 2002b) Source: <http://www.nistreview.org/WTC-ASTANEH.pdf>

Suggestion for Revision:

Comment: 23 with 4 pages

Our model of the collapse of the building predicted all the horizontal beams to buckle at the same time, or buckle individually without relieving constraints on the other beams.

OR

We modeled the disintegrating structure using buckled beams..

Comment 24

Issue: How was this possible?

Location: page 43 of 115 of pdf, (labeled page 5 of report)

http://wtc.nist.gov/media/NIST_NCSTAR_1A_for_public_comment.pdf

1.2.3 The Structure

WTC 7 was an irregular trapezoid, approximately 100 m (329 ft) long on the north face and 75 m (247 ft) long on the south face, 44 m (144 ft) wide, and 186 m (610 ft) tall. The 47 story building contained approximately **200,000 m² (2 million ft²) of floor area**. A typical floor was similar in size to a football field. The gross floor area was about 75 percent of that contained in the Empire State Building. As shown in Figure 1 3, about half of WTC 7 rose outside the footprint of the Con Edison substation.

Figure 78. [**emphasis added**]

page 43 of 115 of pdf, (labeled page 5 of report) http://wtc.nist.gov/media/NIST_NCSTAR_1A_for_public_comment.pdf



Figure 79.

(pre 9/11/01) Source: <http://forums.therandthodeshow.com/index.php?act=Attach&type=post&id=19357> Image217a.jpg

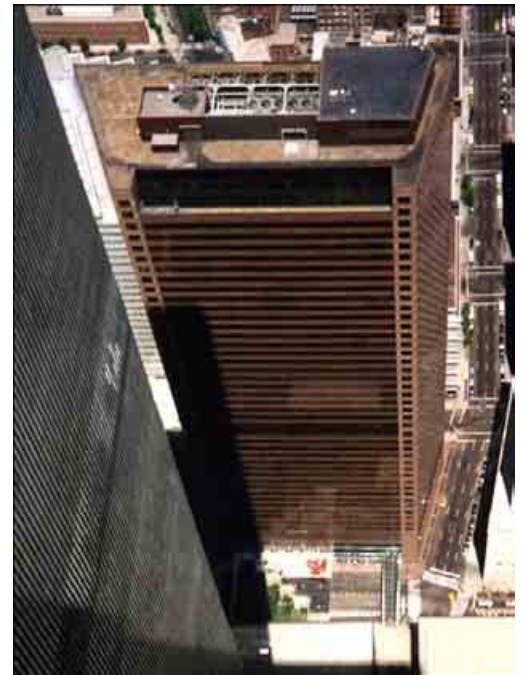

Figure 80. WTC7 before

Source: (pre 9/11/01) Source: <http://356.photobucket.com/albums/g171/boboboffin2/911/WTC7ConfromWTC2.jpg>



Figure 81. A view south on West Broadway shows that the

debris from WTC7 didn't even reach across the street to the Postal Building. (9/12-13/01)

[Source: http://www.hybridch.com/source/eyewitness/complex/081.jpg](http://www.hybridch.com/source/eyewitness/complex/081.jpg)



Figure 82. Debris from WTC7 did not reach the sidewalk adjacent to the Postal Building. (post 9/11/01) [Source: http://forums.therandirhodesshow.com/index.php?act=Attach&type=post&id=19357](http://forums.therandirhodesshow.com/index.php?act=Attach&type=post&id=19357)



Figure 83.

Source: http://wtc7.net/docs/gz_aerial_wtc7.jpg

Reason for Comment: Nature of debris is inconsistent with a gravity-driven collapse.

A full analysis is necessary of expected debris pile volume and mass. This analysis should then compare with the slumped pile that is noted in pictorial evidence. Comparisons should also be made of composition and organization of the debris field as compared with modeled expectations. It is expected that structural steel debris will fall in a random order, not the organized layout seen within the pile. Further, concrete debris should exist in large chunks, medium size pieces, small pieces, and smaller rubble. This is inconsistent with the nearly uniform dirt/mud consistency seen in the pile

Suggestion for Revision:

The answer to the question, "Where did the debris go?" is [provide answer].

Comment 25

Issue: A building turns to mud.

Location: page 304 of 382 of pdf, (labeled page 642 of report) http://wtc.nist.gov/media/NIST_NCSTAR_1-9_vol2_for_public_comment.pdf



Source: G&S Technologies, reproduced with permission

Figure 84. Figure A9. Con Edison transformer #7 (or #5) uncovered from debris pile of WTC 7; photo taken midOctober, 2001.

page 304 of 382 of pdf, (labeled page 642 of report) http://wtc.nist.gov/media/NIST_NCSTAR_1-9_vol2_for_public_comment.pdf

Reason for Comment:

Dirt/Mud shown in Figure 84 is not properly explained. A gravity driven collapse alone would not produce this type of result, or this pile of material. A closer and more detailed analysis of evidence is needed including neatness, composition (e.g. mud and dirt observed in some pictures), fuming, rusting, etc.



Figure 85. A view of the WTC7 dirt pile from Barclay Street.
(9/20/01)

Suggestion for Revision:

NIST has no current explanation for the dirt/mud that encasing transformers in the remains of the WTC which it documented had occurred. NIST understands that its failure to do so may be a part of the basis for a claim of fraud that will be filed by Dr. Judy Wood.

Comment 26

Issue: Incorrect description of Bar/Beam shape

Location: page 56 of 170 of pdf (labeled page 4 of report), http://wtc.nist.gov/media/NIST_NCSTAR_1-9A_for_public_comment.pdf

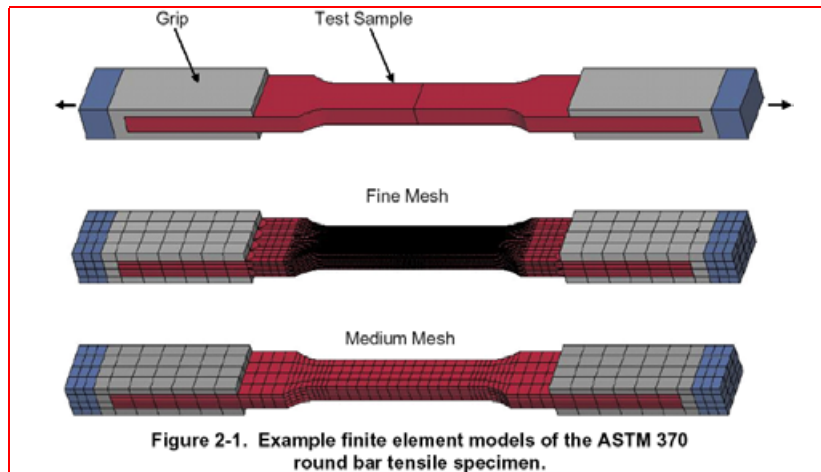

Figure 86.
 page 56 of 170 of pdf (labeled page 4 of report),
http://wtc.nist.gov/media/NIST_NCSTAR_1-9A_for_public_comment.pdf

Reason for Comment: Figure caption is not consistent with the image shown. Figure 85 and the commentary describing it should be corrected to accurately describe the image shown.

Shown below are two diagrams found in the technical literature that are described as "round-bar" specimens. The second one is a finite element model of such a specimen.

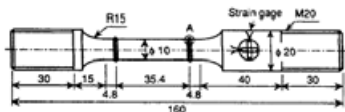

Figure 1: Geometry of round-bar specimen used for dynamic tension tests.

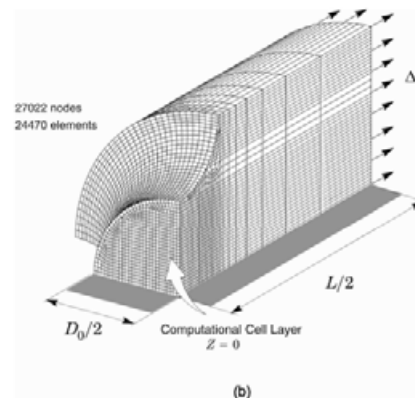

Figure 6. Finite element 3-D models for the tensile specimens employed in the analyses: (a) round bar specimen; (b) circumferentially notched specimen).

Figure 87. FRACTURE PROPERTIES OF HIGH STRENGTH LOW ALLOY STEELS UNDER DYNAMIC LOADING
 Zdravko Praunseis1*, Masao Toyoda2
 Page 4 of 7,
<http://www.umt.fme.vutbr.cz/osem/pdf/ean2001/praunseis.pdf>

Figure 88.
J. Braz. Soc. Mech. Sci. & Eng. vol.26 no.2
Rio de Janeiro Apr./June 2004
Numerical investigation of constraint effects on ductile fracture in tensile specimens
C. Ruggieri
http://www.scielo.br/scielo.php?script=sci_arttext&pid=S1678-58782004000200011&nrm=iso&tlng=pt
<http://www.scielo.br/img/revistas/jbsmse/v26n2/21054f6b.gif>

Suggestion for Revision:
 [describe properly]

Comment 27

Issue: Stress-strain curves are shown for tension, but according to the text, the beams were loaded in compression.

Location: 58 of 170 of pdf (labeled page 6 of report), page 61 of 170 of pdf (labeled page 9 of report), http://wtc.nist.gov/media/NIST_NCSTAR_1-9A_for_public_comment.pdf

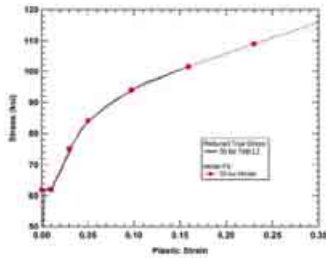

Figure 2-3. Tabular true stress-strain constitutive model curve for the 50 ksi (345 MPa) steel.

Figure 89.

page 58 of 170 of pdf (labeled page 6 of report), http://wtc.nist.gov/media/NIST_NCSTAR_1-9A_for_public_comment.pdf

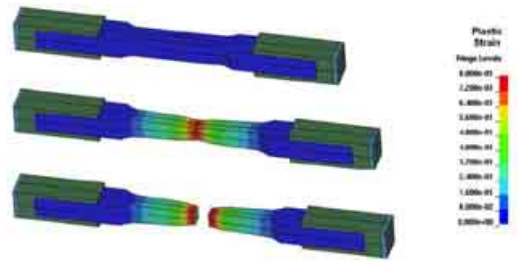

Figure 2-4. Calculated tensile test response with necking for the 50 ksi (345 MPa) steel.

Figure 90.

page 58 of 170 of pdf (labeled page 6 of report), http://wtc.nist.gov/media/NIST_NCSTAR_1-9A_for_public_comment.pdf

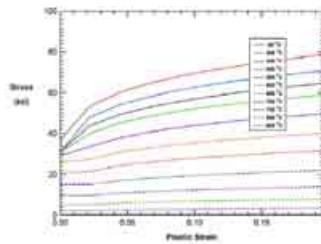

Figure 2-7. Stress-strain curves of the 50 ksi (345 MPa) structural steel as a function of temperature.

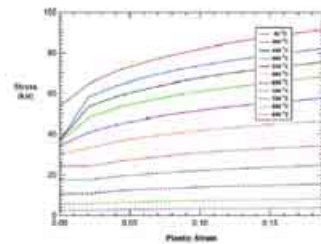

Figure 2-8. Stress-strain curves of the 50 ksi (345 MPa) structural steel as a function of temperature.

Figure 91. page 61 of 170 of pdf (labeled page 9 of report), http://wtc.nist.gov/media/NIST_NCSTAR_1-9A_for_public_comment.pdf

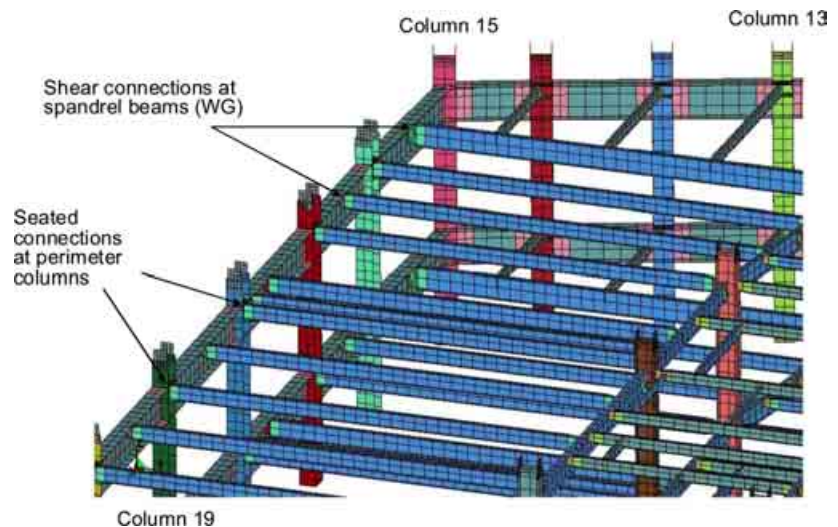

Figure 310. STP connection in global model, view of southwest corner above Floor 9.

Figure 92. floor connections page 78 of 170 of pdf (labeled page 26 of report), http://wtc.nist.gov/media/NIST_NCSTAR_1-9A_for_public_comment.pdf

Reason for Comment: NIST has focused on tensile tests and tensile data for material that is claimed to have failed in compression in a not-clearly-defined environmental.

Suggestion for Revision: Tension diagrams are shown because.

Comment 28

Issue: Observed fuming pattern not properly defined or explained

Location: Page 271 of 404 of pdf (labeled page 227 of report), Page 158 of 404 of pdf (labeled page 114 of report), Page 161 of 404 of pdf (labeled page 117 of report), http://wtc.nist.gov/media/NIST_NCSTAR_1-9_Vol1_for_public_comment.pdf



Figure 5–141. Frame from a video shot from near the corner of West Broadway and Barclay Street showing the eastern side of the north face of WTC 7 between 3:53 p.m. and 4:02 p.m. The intensities have been adjusted, and column and floor numbers have been added.

Figure 93. Page 271 of 404 of pdf (labeled page 227 of report), http://wtc.nist.gov/media/NIST_NCSTAR_1-9_Vol1_for_public_comment.pdf



Figure 5–24. Cropped photograph of the west face of WTC 7 shot from West Street between 3:30 p.m. and 4:30 p.m. on September 11. The structure on the left is the Verizon Building, and the building just visible at the bottom is WTC 6. The intensity levels have been adjusted.

Figure 94. Page 158 of 404 of pdf (labeled page 114 of report), http://wtc.nist.gov/media/NIST_NCSTAR_1-9_Vol1_for_public_comment.pdf



Figure 5–27. Cropped photograph showing the dust cloud created by the collapse of WTC 2. The image was shot from the west at 10:03:56 a.m. WTC 7 can barely be seen above the cloud. The intensity levels of the photograph have been adjusted.

Figure 95. Page 161 of 404 of pdf (labeled page 117 of report), http://wtc.nist.gov/media/NIST_NCSTAR_1-9_Vol1_for_public_comment.pdf

The theoretical time for free fall (i.e., neglecting air friction), was computed from,

$$t = \sqrt{\frac{2h}{g}}$$

where t is the descent time (s), h is the distance fallen (ft), and g is the gravitational acceleration constant, 32.2 ft/s² (9.81 m/s²). **Upon substitution of $h = 242$ ft.** in the above equation, the estimated free fall time for the top of the north face to fall 18 stories was approximately 3.9 s. The uncertainty in this value was also less than 0.1 s.

Thus, the actual time for the upper 18 stories to collapse, based on video evidence, was approximately 40 percent longer than the computed free fall time and was consistent with physical principles.

Figure 96. [emphasis added] page 79 of 115 of pdf, (labeled page 41 of report), http://wtc.nist.gov/media/NIST_NCSTAR_1A_for_public_comment.pdf



Figure 5–157. Frame taken from a video clip shot from the northeast, showing the north face of WTC 7 within a few minutes of the WTC 7 collapse at 5:20:52 p.m. The intensity levels were adjusted.

Figure 97. Page 285 of 404 of pdf (labeled page 241 of report), http://wtc.nist.gov/media/NIST_NCSTAR_1-9_Vol1_for_public_comment.pdf



Figure 5–209. Frame from the Camera 6 video clip in Figure 5–189, showing the north face of WTC 7 10.0 s \pm 0.2 s after the east penthouse began to descend. The intensities have been adjusted.

Figure 98. Page 327 of 404 of pdf (labeled page 283 of report), http://wtc.nist.gov/media/NIST_NCSTAR_1-9_Vol1_for_public_comment.pdf



Figure 5–212. Frame from the Camera 6 video clip in Figure 5–189, showing the north face of WTC 7 11.0 s \pm 0.2 s after the east penthouse began to move downward. The intensities have been adjusted.

Figure 99. Page 328 of 404 of pdf (labeled page 284 of report), http://wtc.nist.gov/media/NIST_NCSTAR_1-9_Vol1_for_public_comment.pdf

Reason for Comment: Analysis is incomplete and does not address the disintegration of the building. If the top portion of the building "fell" at near free-fall speed, it would have encountered no more resistance from the lower portions than from air. But, the building disintegrated while falling as if it encountered very high resistance. Here we have conditions which contradict each other and which NIST fails to address, much less explain. In fact, the observed conditions are consistent with unusual energy effects that are obvious and

that mandate explanation. The failure to address the observed conditions may be evidence of fraud and/or criminal wrongdoing.



Figure 100. WTC7 appears to be dissolving.

Source: [img001.jpg](#)



Figure 101. WTC7 appears to be dissolving.

Source: [NYC14148.jpg](#)



Figure 102.

WTC1 lathering up shortly after the destruction of WTC2. This is a distinctive phenomenon. This occurred prior to the "initiation of collapse" of WTC1.



Figure 103. WTC1 disintegrated while falling.

Suggestion for Revision:

We have no explanation for for what caused WTC7 to dissolve and if there are those who wish to assert that our failure to address this is fraudulent, then they may do so. We acknowledge being placed on notice of this claim of fraud in comments received from Dr. Judy Wood.

Comment 29

Issue: Models given do not match enough of observed phenomena, nor to they explain resulting state of WTC 7

Location: slide 11 of 17 of News Briefing slide,, page 160 of 170 of pdf (labeled page 108 of report),

http://wtc.nist.gov/media/NIST_NCSTAR_1-9A_for_public_comment.pdf



Figure 104.
slide 11 of 17 of News Briefing slide,
http://wtc.nist.gov/media/WTC7_News_Briefing_082008.pdf

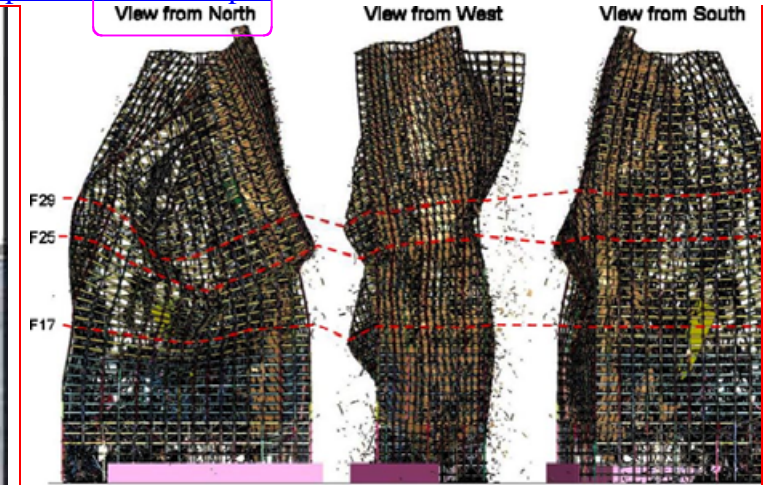

Figure 105.
page 160 of 170 of pdf (labeled page 108 of report),
http://wtc.nist.gov/media/NIST_NCSTAR_1-9A_for_public_comment.pdf

Reason for Comment:

Modeling of the progressive/global collapse shows the building contorting, flexing and losing its shape. This is inconsistent with pictorial and video evidence. Observed evidence is the truth theory must mimic. The diagrams in Figure 105 do not mimic the real event, shown in Figure 104. The models presented are inadequate as explanations for the data/phenomena briefly outlined in parts of this document.

Suggestion for Revision:

We are unable to explain the observed phenomena, so have ignored them. We acknowledge being placed on notice of this claim of fraud in comments received from Dr. Judy Wood.

Once again, the comment period is woefully insufficient for full and fair public comment. Additional time should be provided. If more time is provided, then I will offer additional comments.

In addition, on February --, 2008, I submitted a detailed report calling attention to ongoing clear and present danger arising from nonself-quenching toxicity arising from the evidence of use of exotic weaponry to destroy the WTC complex. NIST did not ever indicate acknowledgment of those concerns. The draft WTC 7 report continues the ongoing process of deception and of disregard of the public's right to know why and how the WTC complex was destroyed. That situation is a travesty.

If there are any questions concerning these submitted comments, please contact either me or my below-listed counsel.

Comment: 28 with 6 pages

Respectfully,

Dr Judy Wood

cc

Jerry V. Leaphart, Attorney

8 West Street

Suite 203

Danbury, CT 06810

p-203-825-6265

f-203-825-6256

e-jsleaphart@cs.com